

**Terrestrial Trunked Radio (TETRA);
Voice plus Data (V+D);
Designers' guide;
Part 5: Guidance on numbering and addressing**



Reference

RTR/TETRA-03197

Keywords

addressing, TETRA

ETSI

650 Route des Lucioles
F-06921 Sophia Antipolis Cedex - FRANCE

Tel.: +33 4 92 94 42 00 Fax: +33 4 93 65 47 16

Siret N° 348 623 562 00017 - NAF 742 C
Association à but non lucratif enregistrée à la
Sous-Préfecture de Grasse (06) N° 7803/88

Important notice

Individual copies of the present document can be downloaded from:

<http://www.etsi.org>

The present document may be made available in more than one electronic version or in print. In any case of existing or perceived difference in contents between such versions, the reference version is the Portable Document Format (PDF). In case of dispute, the reference shall be the printing on ETSI printers of the PDF version kept on a specific network drive within ETSI Secretariat.

Users of the present document should be aware that the document may be subject to revision or change of status. Information on the current status of this and other ETSI documents is available at

<http://portal.etsi.org/tb/status/status.asp>

If you find errors in the present document, please send your comment to one of the following services:

http://portal.etsi.org/chaicor/ETSI_support.asp

Copyright Notification

No part may be reproduced except as authorized by written permission.
The copyright and the foregoing restriction extend to reproduction in all media.

© European Telecommunications Standards Institute 2010.
All rights reserved.

DECT™, **PLUGTESTS™**, **UMTS™**, **TIPHON™**, the TIPHON logo and the ETSI logo are Trade Marks of ETSI registered for the benefit of its Members.

3GPP™ is a Trade Mark of ETSI registered for the benefit of its Members and of the 3GPP Organizational Partners.

LTE™ is a Trade Mark of ETSI currently being registered

for the benefit of its Members and of the 3GPP Organizational Partners.

GSM® and the GSM logo are Trade Marks registered and owned by the GSM Association.

Contents

Intellectual Property Rights	6
Foreword.....	6
1 Scope	7
2 References	7
2.1 Normative references	7
2.2 Informative references.....	8
3 Definitions and abbreviations.....	8
3.1 Definitions.....	8
3.2 Abbreviations	10
4 Background	11
4.1 ETO workshop	11
4.2 Conflict between identities	12
4.3 Implications.....	12
5 Numbers used.....	13
5.1 Structure and format of the ITSI	13
5.1.1 Structure and format	13
5.1.2 TETRA Mobile Country Code.....	13
5.1.3 Multi-Vendor Networks.....	13
5.2 Structure and format of the IMSI	14
5.2.1 Structure and format	14
5.3 Interworking.....	14
5.3.1 General.....	14
5.3.2 Interconnection	14
5.3.3 Migration	15
5.3.4 E.164 numbers	15
5.4 Private Numbering Plans.....	15
5.4.1 General.....	15
5.4.2 RUN (Radio User Number)	16
5.4.3 FSSN (Fleet Specific Short Number)	16
5.4.4 SS-SNA (Supplementary Service - Short Number Addressing)	16
5.4.5 PNP management.....	17
5.5 Groups	17
6 Dialling plans and algorithms.....	17
6.1 General	17
6.2 Mode buttons.....	17
6.3 Leading digit	18
6.4 Emergency numbers	18
7 Numbering scenarios.....	18
7.1 General	18
7.2 TETRA to TETRA calls in Trunked Mode Operation	18
7.2.1 General.....	18
7.2.2 Private TETRA network	18
7.2.3 Public TETRA networks.....	19
7.3 TETRA to TETRA Direct Mode Operation	19
7.3.1 DMO individual call	19
7.3.2 DMO group calls	19
7.4 TETRA to TETRA migration.....	19
7.4.1 PNP.....	19
7.4.2 ITSI.....	20
7.5 TETRA to public network interworking	20
7.5.1 Assumptions	20
7.5.2 Description 1 - SwMI directly connected to the PSTN.....	20

7.5.3	Description 2 - via PABX	20
8	TETRA migrated to other mobile technology	20
8.1	Introduction	20
8.2	Relating TETRA Mobile Network Codes E.218 to E.212 Mobile Network Codes	21
8.2.1	Translation of E.218 (T)MNC and E.212 MNC	22
8.2.2	Alignment of E.218 (T)MNC and E.212 MNC	23
Annex A:	Transmission of numbers and addresses over the Air Interface	26
A.1	Numbering implementations	26
A.2	TETRA to TETRA calls Trunked Mode Operation	26
A.2.1	Private TETRA network	26
A.2.1.1	Current network	26
A.2.1.2	Shortened dialling to Current TETRA network	27
A.2.1.3	Relative dialling to home TETRA network	27
A.2.1.4	Predefined TETRA network	28
A.2.1.5	Any TETRA network	28
A.2.1.6	Short number dialling	29
A.2.1.7	Group call addressing	30
A.2.2	Public TETRA networks	30
A.2.2.1	E.164 domain	30
A.2.2.2	ISDN	31
A.2.2.3	Group call addressing	31
A.3	TETRA to TETRA Direct Mode Operation	31
A.3.1	DMO individual call	31
A.3.2	DMO group calls	32
A.4	TETRA to TETRA migration	32
A.5	TETRA to public network interworking	32
A.5.1	Description 1 - SwMI directly connected to the PSTN	32
A.5.2	Description 2 - via PABX	32
A.5.2.1	PABX	32
A.6	Summary of address exchange over the air interface	33
A.7	Data services	34
A.8	Special numbers	34
Annex B:	Radio User Number	36
B.1	Service overview	36
B.2	Radio User Assignment	36
B.3	Radio User Number	36
B.4	Information flows	37
B.4.1	Mobile Station authentication	37
B.4.2	Radio user authentication	38
B.4.3	Group communications	39
B.4.4	Group voice communications	39
B.4.5	Group SDS/status messaging	41
B.4.6	Mobile station to mobile station communications	41
B.4.6.1	General	41
B.4.6.2	Mobile station to mobile station voice calling	41
B.4.6.3	Mobile station to mobile station SDS messaging	43
B.4.7	Mobile station - PTN communications	43
B.4.7.1	Mobile station to PTN voice calling	43
B.4.7.2	PTN to mobile station calling	44
B.4.8	Mobile Station - PSTN communications	45
B.4.8.1	Mobile Station to PSTN communications	45
B.4.8.2	PSTN to mobile station communications	46

Annex C:	Fleet Short Specific Numbering.....	48
C.1	Introduction	48
C.1.1	Purpose	48
C.1.2	Scope	48
C.2	Fleet Specific Short Number (FSSN)	48
C.2.1	Protocol specification documents	48
C.2.2	Service overview	48
C.2.3	Needed number conversions.....	49
C.2.4	Call to FSSN.....	49
C.2.4.1	Individual call	49
C.2.4.2	Group call	49
C.2.5	Two tier system	49
C.3	Signalling examples	50
C.3.1	Individual call using FSSN.....	50
C.3.2	Group call within single FSSN domain using FSSN for CPI/TPI.....	50
C.3.3	Group call maintenance using FSSN for TPI	51
C.3.4	Individually and group addressed status messages.....	52
C.3.5	Individually and group addressed SDS text messages.....	53
Annex D:	Pre defined gateway and server addresses	54
Annex E:	Bibliography	55
Annex F:	Change requests	56
History		57

Intellectual Property Rights

IPRs essential or potentially essential to the present document may have been declared to ETSI. The information pertaining to these essential IPRs, if any, is publicly available for **ETSI members and non-members**, and can be found in ETSI SR 000 314: "*Intellectual Property Rights (IPRs); Essential, or potentially Essential, IPRs notified to ETSI in respect of ETSI standards*", which is available from the ETSI Secretariat. Latest updates are available on the ETSI Web server (<http://webapp.etsi.org/IPR/home.asp>).

Pursuant to the ETSI IPR Policy, no investigation, including IPR searches, has been carried out by ETSI. No guarantee can be given as to the existence of other IPRs not referenced in ETSI SR 000 314 (or the updates on the ETSI Web server) which are, or may be, or may become, essential to the present document.

Foreword

This Technical Report (TR) has been produced by ETSI Technical Committee Terrestrial Trunked Radio (TETRA).

The present document is part 5 of a multi-part deliverable covering TETRA Voice plus Data designer's guide, as identified below:

- ETR 300-1: "Overview, technical description and radio aspects";
- ETR 300-2: "Radio channels, network protocols and service performance";
- TR 102 300-3: "Direct Mode Operation (DMO)";
- ETR 300-4: "Network management";
- TR 102 300-5: "Guidance on numbering and addressing".**
- TR 102 300-6: "Air Ground Air".

The present document, respect to the previous version, reflects an increased understanding about the role of TETRA numbering E.218 [i.16], and the perception of its relationship with other numbering resources, such as E.212 [i.5], Public Land Mobile Network codes, and E.164 [i.4], telephone Numbers. The versatility of TETRA numbering to support implementations that are both public and private has created the need to extend the scope of the present document by including, in explicit recognition of the versatility, additional concepts such as Private Numbering Plans. The versatility of TETRA numbering brought with it a number of concerns regarding the impact of its implementation in a public arena. The changes in the present document are meant to directly address those concerns by advising implementors how they can best avoid the issues.

1 Scope

The present document gives guidance on TETRA numbering.

The TETRA technology is a method of mobile communication that meets the needs of a broad range of applications. In order to support these roles it offers an increased range of methods of numbering by comparison with the widely used GSM technology. Whilst GSM is optimized to carry out a limited range of functions both cheaply and efficiently, TETRA offers an alternative for those operations for which the requirements are more complex.

The present document offers a summary of:

- The most widely used methods of numbering and addressing which are available in TETRA E.218 [i.16].
- The relationship to the numbering systems of the other major mobile and fixed technologies (E.164 [i.4] and E.212 [i.5]).
- The manner in which the numbers should be used in private and public applications.
- How the numbers are dialled in various applications of the technology.

Two stage signalling, as described in ETS 300 392-4-1 [i.2], annex A and DTMF signalling for any purpose as described in EN 300 392-2 [i.9], clause 14.5.1.2.5, is outside the scope of the present document.

The User Interfaces that may exist to support the user entering the numbers that may exist are outside the scope of the present document.

2 References

References are either specific (identified by date of publication and/or edition number or version number) or non-specific.

- For a specific reference, subsequent revisions do not apply.
- Non-specific reference may be made only to a complete document or a part thereof and only in the following cases:
 - if it is accepted that it will be possible to use all future changes of the referenced document for the purposes of the referring document;
 - for informative references.

Referenced documents which are not found to be publicly available in the expected location might be found at <http://docbox.etsi.org/Reference>.

NOTE: While any hyperlinks included in this clause were valid at the time of publication ETSI cannot guarantee their long term validity.

2.1 Normative references

The following referenced documents are indispensable for the application of the present document. For dated references, only the edition cited applies. For non-specific references, the latest edition of the referenced document (including any amendments) applies.

Not applicable.

2.2 Informative references

The following referenced documents are not essential to the use of the present document but they assist the user with regard to a particular subject area. For non-specific references, the latest version of the referenced document (including any amendments) applies.

- [i.1] ETSI EN 300 392-1: "Terrestrial Trunked Radio (TETRA); Voice plus Data (V+D); Part 1: General network design".
- [i.2] ETSI ETS 300 392-4-1: "Terrestrial Trunked Radio (TETRA); Voice plus Data (V+D); Part 4: Gateways basic operation; Sub-part 1: Public Switched Telephone Network (PSTN)".
- [i.3] ETSI ETS 300 392-4-2: "Terrestrial Trunked Radio (TETRA); Voice plus Data (V+D); Part 4: Gateways basic operation; Sub-part 2: Integrated Services Digital Network (ISDN) gateway".
- [i.4] ITU-T Recommendation E.164 (1997): "The International Public Telecommunication Numbering Plan".
- [i.5] ITU-T Recommendation E.212: "The International Identification Plan for Mobile Terminals and Mobile Users".
- [i.6] ITU-T Recommendation E.331: "Minimum user-terminal interface for a human user entering address information into an ISDN terminal".
- [i.7] ETSI ETS 300 392-10-7: "Terrestrial Trunked Radio (TETRA); Voice plus Data (V+D); Part 10: Supplementary services stage 1; Sub-part 7: Short number addressing".
- [i.8] ETSI ETS 300 392-12-7: "Terrestrial Trunked Radio (TETRA); Voice plus Data (V+D); Part 12: Supplementary services stage 3; Sub-part 7: Short Number Addressing (SNA)".
- [i.9] ETSI EN 300 392-2: "Terrestrial Trunked Radio (TETRA); Voice plus Data (V+D); Part 2: Air Interface (AI)".
- [i.10] TTR001-7: "TETRA Memorandum of Understanding (TETRA MoU); TETRA Interoperability Profile (TIP) version 4, Part 7: Fleet Specific Short Number (FSSN)".
- [i.11] Council Decision 91/396/EEC on the introduction of a single European emergency call number.
- [i.12] ETSI EN 300 392-5: "Terrestrial Trunked Radio (TETRA); Voice plus Data (V+D); Part 5: Peripheral Equipment Interface (PEI)".
- [i.13] ETSI EN 300 812-2: "Terrestrial Trunked Radio (TETRA); Security aspects; Subscriber Identity Module to Mobile Equipment (SIM-ME) interface".
- [i.14] TETRA Memorandum of Understanding (TETRA MoU) TTR001-17: "Radio User Authentication (RUA)".
- [i.15] ETSI EN 300 392-7: "Terrestrial Trunked Radio (TETRA); Voice plus Data (V+D); Part 7: Security".
- [i.16] ITU-T Recommendation E.218: "Management of the allocation of terrestrial trunk radio Mobile Country Codes".

3 Definitions and abbreviations

3.1 Definitions

For the purposes of the present document, the following terms and definitions apply:

alignment: refers to the means by which the MNC of the ITSI is related to the MNC of the IMSI by both having the same numerical representation

dialling: action of selecting the number to be used in a communication

dialling algorithm: process that generates the numbering elements required by the signalling protocol based on user input to the mobile terminal

fleet: set of subscribers organized into a closed user group who can communicate using a *private numbering plan* operated within an *FSSN domain*

Fleet Specific Short Number (FSSN): private number of up to 6 decimal digits allocated to a subscriber to enable short number dialling to other members of the same FSSN domain

NOTE: An FSSN enables intra and inter-fleet dialling within each FSSN domain. The same FSSN number space can be re-used in every FSSN domain.

FSSN domain: organization of fleets using a private numbering plan to enable the members to communicate within their FSSN domain using FSSN dialling

NOTE: Multiple FSSN domains can exist within a single network, each domain using the same FSSN number space. Calls between FSSN domains are not possible using FSSN dialling.

group: set of individual subscribers for which a GTSI is defined

NOTE: The group is assigned a unique *GSSI*, which maps to the set of ISSIs. The GSSI is used to address the entire group during signalling. Individual subscribers can be members of more than one group and groups can be dynamically created, edited or deleted.

Group Short Subscriber Identity (GSSI): short form TETRA group identity

Group TETRA Subscriber Identity (GTSD): long form TETRA group identity

NOTE: The long form of group identity consists of the (T)MCC + (T)MNC + GSSI.

home network: network where a subscriber has a direct subscription

NOTE: This means that a subscriber identity has been allocated in advance of any network access.

International Mobile Subscriber Identity (IMSI): string of decimal digits that identifies a unique mobile terminal or mobile subscriber internationally

NOTE 1: The number of digits is up to a maximum of 15.

NOTE 2: The IMSI consists of three fields: the MCC, the MNC and the MSIN, refer to E.212 [i.5].

NOTE 3: TETRA uses another number resource than IMSI, refer to E.218 [i.16].

Individual Short Subscriber Identity (ISSI): short form TETRA individual identity

Individual TETRA Subscriber Identity (ITSI): long form TETRA individual identity

NOTE: The long form of individual identity consists of the (T) MCC + (T) MNC + ISSI, refer to EN 300 392-1 [i.1] and E.218 [i.16].

Mobile Subscriber Integrated Services Digital Network (MS-ISDN): E.164 number assigned to a mobile subscriber

number: number is a string of decimal digits

NOTE: Numbers are used to derive a route to a termination point in the network.

private number: number in a *private numbering plan* used for dialling to another member of a closed user group

private numbering plan: dialling scheme using private numbers for communication between members of a closed user group

NOTE: The private numbering plan enables total decoupling between a subscriber's private number and ITSI and between a subscriber's private number and E.218 [i.16] number.

Public Telecommunications Operator (PTO): network operator who offers service to the public in accordance with the rules of a national administration, and achieves annex II status, as defined in the relevant European Directive

registration: act of becoming an active and recognized TETRA user by exchange of ITSI with the SwMI (Switching and Management Infrastructure)

Radio User Number (RUN): private number used in a private numbering plan implemented using the external subscriber number field

Short Subscriber Identity (SSI): the network specific portion of a TSI

NOTE 1: An SSI is only unique within one TETRA sub-domain (one TETRA network).

NOTE 2: There are six different types of SSI (see clause 7.2.3 in EN 300 392-1 [i.1]):

- a) Individual SSI (ISSI);
- b) Group SSI (GSSI);
- c) Alias SSI (ASSI);
- d) Un-exchanged SSI (USSI);
- e) Visitor Alias SSI ((V)ASSI);
- f) Visitor Group SSI ((V)GSSI).

TETRA Mobile Network Identifier (MNI): 24 bit encoded number created by the concatenation of the (T)MCC and (T)MNC

translation: means by which the MNC of the ITSI is related to the MNC of the IMSI by both having different numerical representations

transposed FSSN: the SSI obtained by adding the base SSI to the FSSN

NOTE: The default value for the base FSSN is 15 000 000.

two stage dialling: ability to connect to a terminal using a gateway or PABX by first dialling the gateway or PABX and then dialling a subsequent number

NOTE: This applies to incoming calls.

3.2 Abbreviations

For the purposes of the present document, the following abbreviations apply:

(T)MCC	(TETRA) Mobile Country Code
(T)MNC	(TETRA) Mobile Network Code
(V)ASSI	Visitor Alias Short Subscriber Identity
(V)GSSI	Visitor Group Short Subscriber Identity
ASSI	Alias Short Subscriber Identity
A-subscriber	MS initiating a call
B-subscriber	MS receiving a call
CCI	Communications Control Interface (dispatcher interface)
CLI	Calling Line Identity
CPI	Calling Party Identification
DDI	Direct Dialed In
DMO	Direct Mode Operation
ECTRA	European Committee of Telecom Regulatory Authorities
ENF	European Numbering Forum
ESN	External Subscriber Number
ETO	European Telecommunications Office
FSSN	Fleet Specific Short Number
GSM	Special Mobile Group
GSSI	Group Short Subscriber Identity

GTSI	Group TETRA Subscriber Identity
ID	Identity
IMSI	International Mobile Subscriber Identifier
ISDN	Integrated Services Digital Network
ISI	Inter System Interface
ISSI	Individual Short Subscriber Identity
ITSI	Individual TETRA Subscriber Identity
ITU	International Telecommunications Union
MCC	Mobile Country Code
MNC	Mobile Network Code
MNI	Mobile Network Identifier
MoU	Memorandum of Understanding
MS	Mobile Station
MSIN	Mobile Subscriber Identity Number
MS-ISDN	Mobile Subscriber ISDN
NTNA	National TETRA Numbering Administrator
PABX	Private Automatic Branch Exchange
PDU	Protocol Data Unit
PNP	Private Numbering Plan
PSTN	Public Switched Telephone Network
PTN	Private Telephony Network
PTO	Public Telecommunications Operator
RUA	Radio User Assignment
RUN	Radio User Number
SIM	Subscriber Identity Module
SNA	Short Number address
SSI	Short Subscriber Identity
SwMI	Switching and Management Infrastructure
TETRA	Terrestrial Trunk Radio Access
TIP	TETRA Inter-operability Profile
TPI	Talking Party Identification
TSI	TETRA Subscriber Identity
USSI	Un-exchanged Short Subscriber Identity

4 Background

4.1 ETO workshop

The issue of relating TETRA numbering resources to E.212 [i.5] numbering resources was discussed at two workshops in Copenhagen. Out of the first workshop came the recognition that the two resources were distinct, and that they could be seen as distinct as long as the technologies did not interact in any way. However, since some operators want to use dual mode handsets, so that they can support migration on a GSM technology that uses E.212 [i.5] numbering, issues have been raised about how the numbering regimes for the different technologies should be related to each other. As a consequence a second workshop was held (Second ETO workshop on TETRA Copenhagen, 12 January, 2000) where guidance was sought from the regulators via the European Numbering Forum.

The relevant specific actions that the workshop initiated were:

- The workshop requested ENF to monitor the progress of the activity and provide a point for the co-ordination of the technical and regulatory activities on this subject. In particular ENF can decide to establish a Topic Group on TETRA to tackle the numbering issues surrounding TETRA as they arise.
- The workshop requested ECTRA to take the appropriate steps to ensure the establishment of harmonized rules and procedures for the assignment of ITSIs. The workshop identified ECTRA/PT N as the appropriate ECTRA group to deal with this subject. The ETO report on "Harmonized national conventions for naming and addressing" was a valid starting point for the ECTRA/PT N work.
- NRAs were asked to develop national conventions for the administration and management of ITSIs used in public networks.

NOTE: ECTRA PT-N is now known as PT-3.

4.2 Conflict between identities

The following subjects were also discussed in detail at the second ETO workshop in Copenhagen.

If a numerical value assigned to a TETRA identity is also allocated to a different E.212 [i.5] identity there is a potential for conflict.

This potential for conflict is based on a relationship that was not envisaged in the development of the relevant standards. A number of assumptions have been made regarding the manner in which TETRA will interwork with GSM and these assumptions are stated below.

The description of the potential conflict assumes that:

- an allocation of a (T)MCC may be for a country, or group of countries, whilst the same digits in E.212 [i.5] are allocated to a different geographic country;
- the TETRA operator has stored the (T)MCC either in the handset, or in a standard or modified SIM card;
- the modified SIM card is based on those used for GSM; and
- either the handset or the SIM card is used in a country other than the one in which the number was assigned, i.e. it has migrated (called roamed in GSM).

4.3 Implications

The relationship between the E.212 [i.5] IMSI and the TETRA ITSI E.218 [i.16] raises a number of issues, not least because unlike the IMSI, the ITSI, in some circumstances, can be dialled. The co-existence of the two different schemes raises a number of issues for which guidance is given in the present document. The present document provides the guidance for implementers of TETRA networks in which numbering plans have to exist. Co-existence of TETRA Numbering resources (ITSIs) with similar resources of other networks is a driver for the inclusion of preferred alternatives to ITSI dialling.

5 Numbers used

5.1 Structure and format of the ITSI

5.1.1 Structure and format

The structure of ITSI is shown in figure 1, refer to EN 300 392-1 [i.1] and E.218 [i.16].

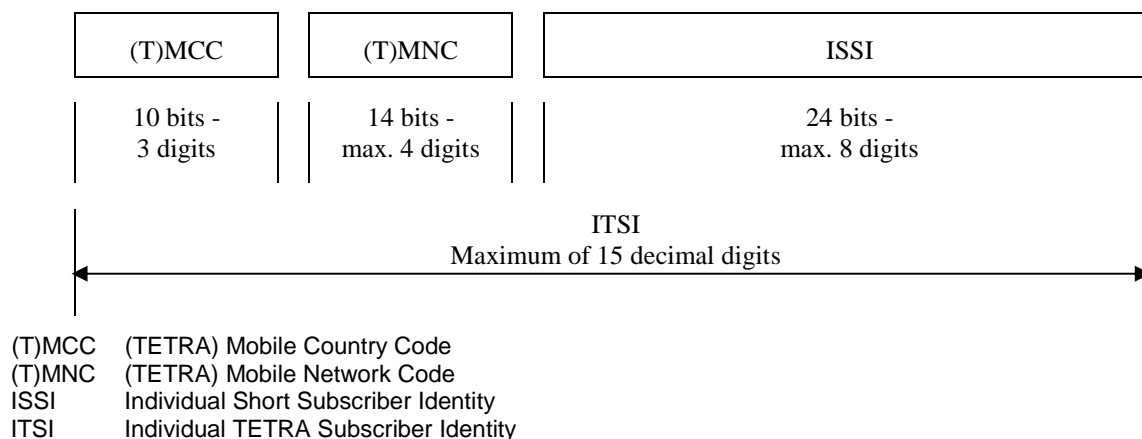

Figure 1: Structure and Format of ITSI

The Individual TETRA Subscriber Identity (ITSI) is the globally unique identity assigned to a TETRA subscriber to enable the subscriber to roam among private and public TETRA networks. The ITSI is used as the calling and called party address within the TETRA signalling. It also enables a visited TETRA network to query a TETRA subscriber's home network for subscription and billing information.

5.1.2 TETRA Mobile Country Code

The TETRA Mobile Country Code, (T)MCC, is administered on an international basis in order to ensure that there is no risk that different countries adopt the same country code. ETSI Project TETRA requested that the group of organizations and administrations who had signed the TETRA Memorandum of Understanding (MoU) should administer the (T)MCCs. The TETRA MoU decided to align the (T)MCCs with the E.212 [i.5] Mobile Country Codes in order to reduce the potential for confusion. In 2002, the TETRA MoU requested that the ITU should manage the (T)MCCs to ensure that there will be no conflict of allocation. In 2004, the ITU-T published recommendation E.218 [i.16] that defines internationally the allocation of E.218 [i.16] (T)MCCs for TETRA.

5.1.3 Multi-Vendor Networks

TETRA has seven open interfaces including one between SwMIs. The link between the SwMIs is called the ISI. Using the ISI it will be possible to build a TETRA network of SwMIs from equipment from more than one manufacturer. TETRA does not specify any intra system interface [i.1]. The advantage is that suppliers of infrastructure are able to develop infrastructures that are optimized for different applications within the market.

The administration of the TETRA Mobile Network Codes is within the decision of the National TETRA Regulatory Authority for TETRA. The administrators will need to be aware that there are conditions under which the provision of more than one TETRA Mobile Network Code to an operator may become necessary. It is possible to construct TETRA networks from equipment from more than one supplier in which the SSI range is divided such that the equipment from one supplier uses one range and that from the other supplier uses the other range. In this manner the ISI may link the networks together and they will appear to both a home terminal and a migrating terminal as a single network.

NOTE: TETRA standards use the term migrating to refer to the same functionality as roaming in the GSM environment.

5.2 Structure and format of the IMSI

5.2.1 Structure and format

The IMSI structure and format are as shown in figure 2.

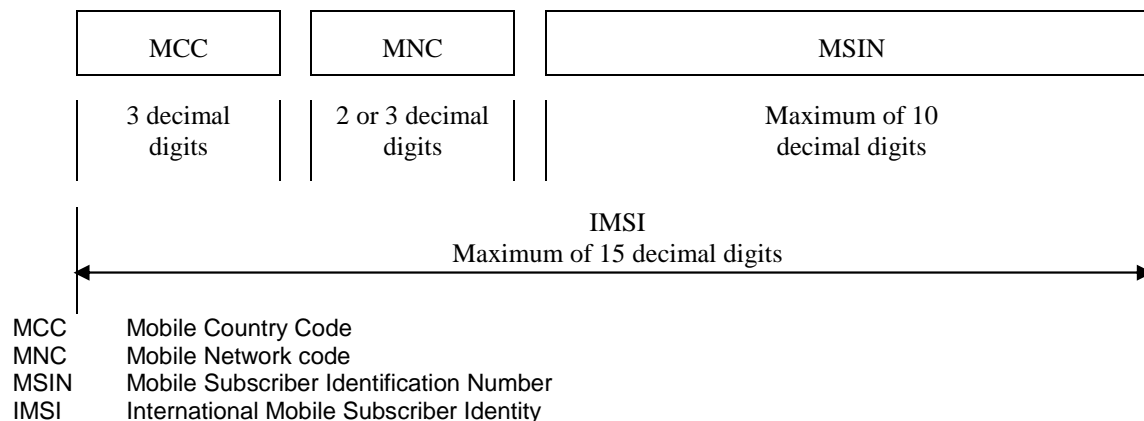

Figure 2: Structure and Format of IMSI

The International Mobile Subscriber Identity (IMSI) is defined as the international identification of a mobile terminal or mobile user, which enables the terminal or user to roam among public networks which offer mobility services. The IMSI enables a visited network to identify a migrating mobile terminal or mobile user, e.g. in order to query a subscriber's home network for subscription and billing information.

5.3 Interworking

5.3.1 General

Interworking between the numbering resources of TETRA and other mobile network technologies occurs when TETRA technology is used to provide services under a Public Telecommunications Operator (PTO) licence. The interworking between the resources can take two forms; interconnection and migration.

Private network operators would normally interwork with the PSTN using either a gateway or a PABX. Under these circumstances, the gateway or PABX is considered to be the point of interconnect between the Private TETRA network and the PSTN. The Private TETRA network is considered to be isolated from the PSTN by the gateway or PABX.

5.3.2 Interconnection

Interconnection is the ability to route calls between TETRA and other network technologies, such as PSTN, ISDN and mobile. The interaction required with the TETRA SwMI, to support call completion, is specified in the TETRA standards.

Outgoing calls to the Public networks such as the PSTN ISDN and GSM would require E.164 [i.4] numbers.

This implies that the operator of a TETRA network would need an allocation of E.164 [i.4] numbers to route calls at the point of interconnection. Also, E.164 [i.4] numbers would be used for CLI on outgoing calls.

For Incoming calls three cases exist:

- Case 1: where the TETRA implementation is public, then E.164 [i.4] numbers would be used.

Case 2: where the TETRA implementation is private then two stage dialling could be supported. This two stage dialling would be via a gateway or PABX. Having dialled the E.164 [i.4] number the caller would be prompted to enter further digits. These further digits could be either numbers from the Private Numbering Plan or an ITSI. Operators choosing to use an ITSI as the second stage should proceed with care.

NOTE 1: The care is required so that in this case the operator will need to ensure that the appropriate security exists at the gateway to stop fraudulent access to the network.

Case 3: where ISDN supplementary service DDI is used to allocate E.164 [i.4] numbers to certain TETRA users.

NOTE 2: The allocation and use of these numbers affects the gateway and not the Air Interface.

5.3.3 Migration

Migration between networks of different technologies requires a relationship to exist between the addresses that are used. In the case of TETRA, a relationship has to exist between the E.218 [i.16] ITSI and similar identities that are used for other technologies. For example, for Public Land Mobile Networks, a relationship would have to exist with E.212 [i.5]. Two methods currently exist. The relationship is discussed in more detail in clause 8.

5.3.4 E.164 numbers

A TETRA network may, if required, interconnect with other public networks (PSTN, ISDN, GSM, etc.) to enable direct communications between TETRA subscribers and subscribers in other fixed and mobile networks. In this respect the TETRA standard adopts existing analogue and a digital interface (TETRA-PSTN [i.2], TETRA-ISDN [i.3]).

Calls are routed between the TETRA network and the other public network through a gateway. This is achieved using a combination of dialling plans and dialling algorithms.

According to the ITU-T Recommendation E.164 [i.4] - the basis of all national numbering plans - it is essential that subscribers migrating on public networks should be reachable using the same number. Thus public TETRA subscribers require E.164 [i.4] numbers to enable them to be called either nationally or internationally from other public networks.

When public TETRA subscribers make calls to other public networks, their E.164 [i.4] numbers can be used for Calling Line Identification (CLI).

5.4 Private Numbering Plans

5.4.1 General

A private numbering plan uses a number space which is completely independent from all others (e.g. E.164 [i.4], TETRA SSI, etc.). Private numbers are allocated to subscribers and enable the members of a private closed user group to communicate. Private numbers are generally shorter than public numbers and are inaccessible from public networks.

Where Private Numbering is separated from Public Numbering E.164 [i.4] numbers by a PABX/Gateway then access may be supported by the facilities of that PABX, e.g. two stage dialling.

Currently, TETRA has two forms of private number; the RUN and the FSSN. Others may be added when required.

Private Numbering Plans are preferred to ITSI dialling, where the TETRA network is interconnected with other Public licensed operators especially mobile operators. If PNP's do not exist, then where the ITSI and IMSI are aligned, end users would effectively become aware of the E.212 [i.5] IMSI, and therefore a potential for cloning would be increased. ITSI dialling is currently preferred where migration to other mobile operators on other technologies, that use E.212 [i.5] IMSI, is not enabled.

The dialling plan, though implemented to support the numbering plan, may use an ITSI gateway address to indicate where the External Subscriber Number (ESN) field may be resolved for routing to a final destination(s).

NOTE: The dialling plan in use should be indicated by the Gateway ITSI used in the Air Interface signalling.

An MNI may be included with an FSSN in order to route signalling and calls to the network where the FSSN can be resolved, if this is not the current network.

5.4.2 RUN (Radio User Number)

The RUN is a private number which, when dialled, is carried in the ESN field in the same way as an E.164 [i.4] number. When the radio is turned on and the user authenticates himself, part of the process is entering his RUN, the RUN is then mapped to a subscriber's unique TETRA identity (ITSI) within the SwMI of the TETRA network. The key advantage of this PNP is that RUN enables the call to be directed towards a user rather than a terminal.

RUNs are completely independent of all other numbers allocated to a TETRA subscriber.

Management of the use of the external number field is achieved by use of a dialling plan.

In addition to the SwMI managing the allocation of a RUN, the SwMI will also resolve:

- the calling RUN from the calling ITSI so that the former can be presented as the CLI; and
- the called ITSI from the called RUN to enable call routing.

Annex B describes RUN in more detail.

5.4.3 FSSN (Fleet Specific Short Number)

Each customer operating a private numbering plan utilizing FSSNs will allocate each subscriber an FSSN. This number is all that the subscriber needs to communicate within a private, closed user entity (FSSN domain). The FSSN is independent of both the ITSI of the called user, and the base SSI.

The FSSN is added to a pre-defined base SSI in the calling user's terminal, and the address formed by the addition is sent in the call set up message. A block of TETRA SSIs, beginning with the base SSI of 15 000 000, is reserved for the implementation of FSSN. This block is not normally used for the allocation of subscriber ISSIs. It is the size of this block which determines the available FSSN range; e.g. a block of one million SSIs enables an FSSN range from 0 to 999 999. This number range can be re-used in as many FSSN domains as is required within the constraint that the maximum number of ISSIs is not exceeded.

Each FSSN maps to a subscriber's globally unique ITSI within the SwMI of the TETRA network. It is the calling subscriber's globally unique ITSI, which is correlated to the subscriber's fleet. The network determines which mapping table is used to translate the FSSN to the ITSI of the called user.

FSSN number space is completely independent of all other numbers allocated to a TETRA subscriber. It enables one or more tiers of dialling; e.g. between members of a single fleet (intra-fleet dialling) and between fleets (inter-fleet dialling).

Annex C describes FSSN in more detail.

5.4.4 SS-SNA (Supplementary Service - Short Number Addressing)

Within the call set up process, there is a facility to utilize an optional short address. In SS-SNA 256 numbers are available, and these can therefore only be used where fleets can accept this limitation. The SS-SNA number can be cross-referred to any ITSI, GTSI, RUN, FSSN or E.164 [i.4] number. The SwMI uses a look-up table to resolve the cross-references to the SNAs. The independence of SNA will allow it to co-exist with both of the above Private Numbering Plans.

SNA is described in ETS 300 392-10-7 [i.7] and in ETS 300 392-12-7 [i.8].

5.4.5 PNP management

The assignment of the SSI, PNP (FSSN or RUN) or SNA is the responsibility of the network operator. If migration to other Public Land Mobile Networks, using other technologies, alignment of the SSI with the private numbering plans or the E.164 [i.4] numbers is not preferred. The ITSIs in this case performs a function similar to that of E.212 [i.5], and for security and avoidance of fraud issues is divorced from the user's number. Therefore this good practice should be extended to this instance. Care should be exercised with regard to the construction and development of the PNP and any impact it may have on emergency numbers, (see clause 6.4). The dialling plan should take account of the forecast future demand in addition to the current demand. Processes should be developed to assign number resources to customers and to have such resources made available on the infrastructure.

5.5 Groups

The TETRA standard defines a point to multi-point (or group) call.

Groups are only accessible from the public E.164 [i.4] numbering space via a gateway or PABX.

A TETRA group is regarded as a single subscriber and thus is allocated a unique TETRA identity - a GTSI. GTSIs have the same format as ITSIs and comprise a (T)MCC + (T)MNC + GSSI. The GSSI is the short form group identity. It has the same format as the ISSI and can be allocated from the same SSI number space.

Within the network subscriber databases may be a mapping between each defined GSSI and its member ISSIs or ITSIs. Two example uses of such a mapping are to restrict access to the GSSI or to record which ISSIs/ITSIs are currently attached to that GTSI. A TETRA subscriber need not belong to any group but has the option to belong to one or more groups.

6 Dialling plans and algorithms

6.1 General

An initial action by the user provides instructions to the terminal as to how the number is to be interpreted. Such action can be either part of the numbers entered or by a selection process. The two primary methods of selecting how the information that has been entered will be interpreted are mode buttons and leading digits. Mode buttons explicitly select the type of number to be sent, whereas leading digits can be either explicit or implicit. It is possible to configure a terminal such that some types of dialling are explicit and some implicit.

For example, if a user, connected to a private network, enters digits that do not include a recognized dialling code that explicitly indicates the call is for external direction, the call is routed internally. However, in a public network the reverse will occur.

In TETRA the following Dialling Plans can exist:

- Mode Buttons.
- Leading Digits.

NOTE: This list is not exhaustive.

6.2 Mode buttons

Though the use of mode buttons is permitted, their detailed description is outside the scope of the present document.

6.3 Leading digit

When users enter a number, the initial digits are structured according to a dialling plan, and this is used to give instructions to a network. The digits that follow are also structured according to a numbering plan. The structure of the dialling plans is such that the information contained within them can either be explicit or implicit.

EXAMPLE: In public networks leading, implicit digits equivalent to the first digit of a national number, in either an open or closed numbering plan, can be used to route calls to the PSTN. Within the same public network, calls routed to groups, SNA, FSSN, RUN etc may either have explicit leading digits or number length analysis performed to determine the number type.

An escape code is an example of an explicit leading digit. This may include characters other than numbers. E.331 [i.6] would be an appropriate method of dialling to access the PSTN from within a private network using a non-numeric digit.

6.4 Emergency numbers

When it is necessary that the TETRA terminal should have access to the national emergency access code(s), then the terminal would use number analysis to separate such numbers from others in use. Typically the European emergency number (112) would be analysed to identify it as an emergency call and direct the call to the appropriate emergency handling facility for that network. The emergency handling facility may include the same facility as on the PSTN.

In developing a private numbering plan, or specifying a dialling plan, care should be exercised to ensure that the national emergency access codes do not clash within the PNP or ITSI.

NOTE: User dial string 112 should be reserved. This is the harmonized number in the European Community for the emergency service, see Council Decision 91/396/EEC [i.11]. Similarly, other service numbers could be harmonized in the future on a national, or international basis.

7 Numbering scenarios

7.1 General

Though permitted currently by the standards, ITSI dialling is not encouraged, and is replaced by Private Numbering Plans in the following descriptions. For public networks where a TETRA operator also has access to an E.212 [i.5] resource then PNP should be used in preference to the ITSI for dialling. Annex A provides further details of how and when the various dialling options can be implemented.

7.2 TETRA to TETRA calls in Trunked Mode Operation

7.2.1 General

Two cases exist. The first is where the network is private, and the second is where the network is considered to be public. These are considered separately.

7.2.2 Private TETRA network

Calls made in this environment may be between two TETRA terminals, between a TETRA terminal and a PABX, or a data connection to an intranet. There would not be a direct connection to the PSTN.

The use of a Private Numbering Plan is preferred, but ITSI dialling is permitted. For those networks that have either a larger user base, or who wish to structure their numbering plan according to a functional or organizationally based structure, then Private Numbering Plans should be considered.

7.2.3 Public TETRA networks

For calls between two TETRA terminals within a public TETRA network, two methods of dialling are available. These are the use of the E.164 [i.4] number, which is independent of the terminal's ITSI, and a private numbering plan, which is also independent of the terminal's ITSI. Public networks should not be designed on the basis of ITSI dialling.

Access to Group, PABX and SNA will be available using leading digit or mode buttons at the discretion of the network operator.

7.3 TETRA to TETRA Direct Mode Operation

7.3.1 DMO individual call

Direct Mode is a radio to radio communication. It is therefore limited to SSI and ITSI dialling only, and available only when the terminal is inaccessible from the PSTN. DMO is simpler than trunked mode operation, being "Press to talk".

DMO only supports the use of ITSI and SSI dialling. Short form dialling in which the SSI or ITSI is created by the expansion of a shorter number from within the terminal is at the discretion of the terminal manufacturer. The call set up process converts destination SSI to a full 48 bit ITSI. Terminals which do not share the same MNI are therefore accessible.

DMO Gateways support the transmission of ITSIs such that terminals on the Trunked Mode network using SSI dialling and ITSI dialling may contact a Direct Mode terminal. They also permit Direct Mode terminals to contact terminals on the trunked network using the ITSI or SSI of the target terminal. If an ISI is implemented between two networks then a gateway will permit a Direct Mode terminal to either call or be called by terminals on the connected network.

7.3.2 DMO group calls

Groups are identified in DMO by their full 48 bit GTSI.

Groups may support terminals from more than one network, or from more than one country. The terminals will send the full GTSI of the destination address.

The method by which the user dials or selects the full GTSI is implementation specific.

7.4 TETRA to TETRA migration

7.4.1 PNP

NOTE: Though migration is used, it has the same meaning as roaming does in the GSM world.

Where the user has roamed to another TETRA network and wishes to make a call either to a user on the visited network or a call to the home network, two assumptions have been made:

- compatibility of PNPs; and
- an ISI which has been extended to support PNP.

Under these circumstances a PNP can be used. If these assumptions are not fulfilled, then it will be necessary either to use ITSI dialling, or that the PNP-related signalling over the air interface uses the full ITSI for the (number conversion) gateway. Then the call will be passed over the ISI to the home network of the non-compatible PNP, using the gateway address ITSI in the PNP's home network as routing information, for the private number to be resolved.

7.4.2 ITSI

The ISI may also connect two private TETRA networks to permit calls from a user on one network to a user on another network. To have the ability to successfully dial the full ITSI of a target terminal on the network to which a user has roamed, then to yield access, it is necessary that:

- the networks are private;
- the ISI has been implemented; and
- ITSI dialling or routeing has been implemented.

7.5 TETRA to public network interworking

7.5.1 Assumptions

Assumptions for dialling:

- TETRA centric, calls originating from the TETRA network.
- Incoming calls from PSTN are dealt with in the manner prescribed for that network, but are not described here.

7.5.2 Description 1 - SwMI directly connected to the PSTN

If the terminal is placed in PSTN mode, then the full national or international E.164 [i.4] number is dialled. The PSTN has a predefined ISSI/ITSI gateway address. This is stored in both the terminal and the network.

The user will be required to inform the terminal and/or the network that what follows is a public number. This is done through the use of dialling plans encoded as dialling algorithms (see clause A.5.2). The dialling process would normally be based on explicit or implicit leading digit dialling plan.

The user may have the option to use either the local PSTN gateway, or the home PSTN gateway.

7.5.3 Description 2 - via PABX

A PABX is physically connected to the TETRA network and has a pre-defined ISSI/ITSI gateway address. This is stored in both the terminal and the network. Where a user has roamed, then two options exist. First by using the full ITSI of the home network PABX, to identify the home network PABX. Access to the home network is provided by the ISI. Alternatively, a user may, with appropriate network operator agreements, use the PABX address of the visited network. The method of connecting preferred by the user may be programmed into the terminal.

8 TETRA migrated to other mobile technology

8.1 Introduction

For the purposes of the present document, GSM is used as the example of the other mobile technology.

Migration is the ability for TETRA customers to take service from service providers who make use of other technologies, and has a number of assumptions associated with it:

- multi-band/dual mode handset;
- appropriate commercial agreements;
- appropriate operator status;
- modified GSM SIM Card;

- E.218 [i.16] (T)MCC and E.212 [i.5] MCC have the same decimal representation;
- E.218 [i.16] (T)MNCs relate to E.212 [i.5] Mobile Network Codes in some manner.

In addition migration is influenced by the approach taken to administration of (T)MNCs by the National TETRA Numbering Administrator (NTNA) [i.5].

A TETRA operator may wish to support access to another technology such as GSM so that customers with dual mode terminals can roam on GSM networks when they are outside the coverage of their home TETRA network.

In order to establish migration agreements, with operators of GSM networks, this will mean that:

- the TETRA-GSM dual mode terminals appears to the visited GSM networks as normal GSM terminals. The GSM network operators are unlikely to be willing to make special modifications just to support these terminals. This means that the terminals presents fully compatible GSM IMSIs;
- the home network appears as a home GSM network to the visited GSM networks for the purposes of authenticating terminal registration, updating locations and receiving call detail records for outgoing calls;
- the home network forwards incoming calls to the visited networks.

TETRA national operators would therefore become a mobile virtual network operator in the GSM environment as well as being a TETRA operator. In dual mode operation, a dual mode terminal will appear to a TETRA network (home or visited) as a normal TETRA terminal, but will appear to a visited GSM network as a normal GSM terminal. It is assumed that no modifications will be made to the GSM networks to facilitate dual mode operation with TETRA. The home TETRA networks that supports dual mode will also have to appear to visited GSM networks as a GSM network or at least a mobile virtual network. This involves operating a GSM style Home Location Register and supporting GSM authentication and charging arrangements.

It may also be possible for a single handset with dual technologies to be subscribed separately on a TETRA network and a wholly different GSM network. This case does not raise any issues of co-ordinating the numbering as there would be wholly separate E.164 [i.4] numbers, ITSIs, IMSIs and authentication keys.

E.218 [i.16] (T)MNCs are independent of other numbering schemes and so may be allocated in whatever manner the NTNA decides. However for an operator who wishes to run dual mode systems with technology that uses E.212 [i.5] IMSIs (e.g. GSM and 3GPP) this clause gives guidance on how the decision taken by the NTNA impacts upon how an operator relates the MNC fields of the ITSI and IMSI to each other.

8.2 Relating TETRA Mobile Network Codes E.218 to E.212 Mobile Network Codes

This clause specifies the relationship associated with the management of the (T)MNC resource.

NOTE 1: No such relationship is required for E.218 [i.16] (T)MCC and E.212 [i.5] MCC because they are already aligned, and no other option is permitted.

Recognizing that the E.218 [i.16] (T)MNC can be up to 4 digits, and that E.212 [i.5] can be either 2 or 3 digits, and that not all TETRA operators/service providers want to roam on to other mobile networks, then the E.218 [i.16] (T)MNC can be used in two ways, by a "Public" TETRA system or by a "Private" TETRA system. There are two ways by which the relationship of a public E.218 [i.16] (T)MNC relates to an E.212 [i.5] MNC, and this relationship has a subsequent impact upon the manner in which the E.218 [i.16] (T)MNC is managed.

There are two options for relating the MNC elements of the ITSI and the IMSI. The method selected is dependent upon the decision taken by the NTNA as to how they manage the resources.

a) Alignment

- To use a common decimal value of the MNC in the IMSI and of the (T)MNC in the ITSI for use with both systems, even though the codings used over the air interface are different.

NOTE 2: This has been called "alignment".

This is where the ITSI and IMSI have identical decimal forms in the MNC field, and they are stored in the mobile. They are valid on the TETRA and GSM network as appropriate.

b) **Translation**

- To have a separate MNC in the IMSI for use with GSM and a separate (T)MNC in the ITSI for use with TETRA.

NOTE 3: This has been called "translation".

This is where the IMSI (GSM) and ITSI (TETRA) decimal values are differentiated at the MNC field stored in the mobile and the relevant one is used depending on the technology used for the call. This means that a home TETRA network that is enabling its dual mode mobiles to roam onto other public land mobile network technologies (e.g. GSM) is able to receive registration authentication requests that use the IMSI. Additionally the home TETRA network should either support dual identifications in its customer management system, or translate the IMSI to an ITSI for use with its customer management/billing system.

NOTE 4: Irrespective of whether alignment or translation is the chosen national method, the management of the SSI is under the control of the operator.

However there is a possibility that the use of a common value could provide some cost savings for the home TETRA operator who is supporting dual mode. It is the responsibility of the NTNA to decide the manner in which they manage and administer these resources. However such a decision could have an impact upon the management required by the operator(s).

The National TETRA Numbering Administrator may wish to facilitate the use of dual mode operation with a common value of IMSI and ITSI. Since the values of the MCCs will already be the same, and since the subscriber number of the IMSI and the Short Subscriber Identity of the ITSI is an internal matter for the operator, the issue is on the impact that the chosen management option has on the approach to the operator.

8.2.1 Translation of E.218 (T)MNC and E.212 MNC

If an NTNA selects translation between the E.218 [i.16] (T)MNC and E.212 [i.5] MNC as the preferred national method to relate the two numbering resources to each other, then the E.218 [i.16] (T)MNC resources can be administered independently of the E.212 [i.5] MNC resources.

There would be no commonality of decimal value between the MNC of the IMSI and the (T)MNC of the ITSI.

In the case of an operator of a dual mode terminal (as described in clause 8.1) who is providing a service where the NTNA has chosen the independent method of allocation, then the operator will have to translate between the E.212 [i.5] MNC and the E.218 [i.16] (T)MNC. Additional time would be required to validate the customer identity in the TETRA management infrastructure, before migration could continue.

An operator who had begun service providing private service, who then evolved to become a public service provider would require no number change.

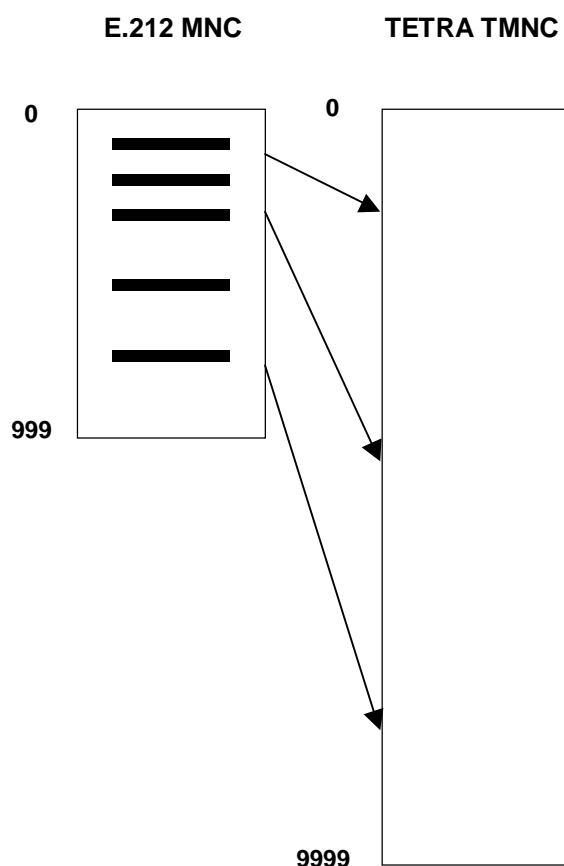

Figure 3: E.212 and (T)MNC Management where the administration supports translation

8.2.2 Alignment of E.218 (T)MNC and E.212 MNC

The following applies only where the National TETRA Numbering Administrator (NTNA) wishes to facilitate dual mode operation with a common value of IMSI and ITSI. Where a common value is not intended, the schemes are totally separate and any E.218 [i.16] (T)MNC value may be allocated without regard to E.212 [i.5] (see clause 8.2.1).

If an NTNA selects alignment between the E.218 [i.16] (T)MNC and the E.212 [i.5] MNC as the preferred national method to relate the two numbering resources to each other, then given the difference in the structure of the resources available, the (T)MNC is divided into two parts. The first part is 0 000 to 0 999 and irrespective of whether 2 or 3 digit MNCs are used will not be allocated unless an E.212 resource has first been allocated. The subsequent range is 1 000 to 9 999.

Figure 4 shows the E.212 [i.5] and E.218 [i.16] TETRA network code numbering spaces alongside each other.

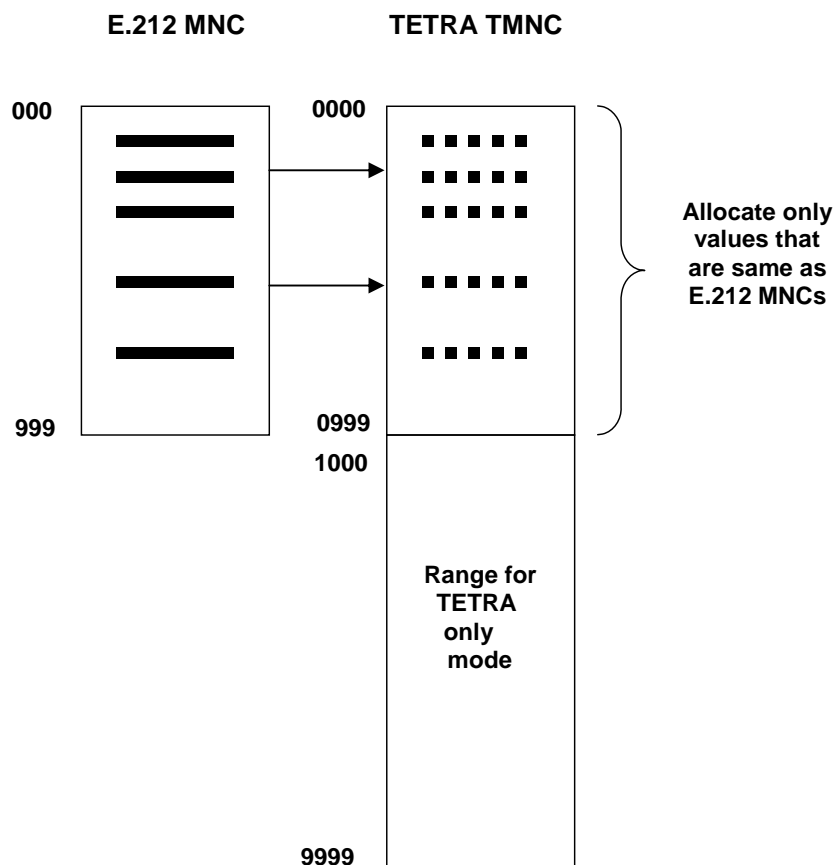

Figure 4: E.212 [i.5] and E.218 [i.16] (T)MNC Management where administrators support aligned values

E.212 [i.5] values have a range from 00 to 999, whereas E.218 [i.16] (T)MNC values have a range from 000 to 9 999. Since the ranges overlap only for the values 00 to 999, TETRA allocations for single mode operation should be limited to the range 1 000 to 9 999.

Where an operator wishes to introduce dual mode operation in this management environment, the operators should first obtain an E.212 [i.5] MNC from the administrator of that numbering space and then the National TETRA Numbering Administrator should allocate the same value in the E.218 [i.16] TETRA (T)MNC space. An operator who is allocated an E.212 [i.5] MNC should get an allocation of a E.218 [i.16] (T)MNC from the initial E.218 [i.16] (T)MNC range that is the same digits. For example, an operator allocated 19 from a national regime using two digit E.212 MNCs, or 319 in a regime using a three digit MNC regime will be allocated the (T)MNCs of 0019 and 0319 respectively. This allocation is done by implication i.e. there is no direct allocation process. Only operators who meet the appropriate regulatory regime for E.212 [i.5] numbers, and who have a need for a E.218 [i.16] (T)MNC, should use the initial E.218 [i.16] (T)MNC range.

E.218 [i.16] TETRA (T)MNC values equivalent to E.212 [i.5] values that have already been allocated to GSM in the range 00 to 999 would be used only if GSM operators add TETRA technology to their networks.

If an operator starts with a private service and a E.218 [i.16] (T)MNC in the range 1 000 to 9 999 and subsequently decides to evolve to a public service where dual mode is used with an aligned approach to the E.212 [i.5] and (T)MNCs, then that operator can either:

- re-number their TETRA network to a new common value in the range 00 to 999; or
- support two separate (T)MNC values, the dual mode one in the range 00 to 999 and the existing value in the range 1 000 to 9 999.

The subsequent range, 1 000 to 9 999, will be used by the operators who wish to use TETRA services, but who either do not wish, or have the need to use the national E.218 [i.16] (T)MNC range that is aligned to the national E.212 [i.5] MNC range.

Any operator who subsequently wishes to avail themselves of access to E.212 [i.5] resources, and meets the appropriate regulatory requirements and who already has an allocation of E.218 [i.16] (T)MNC in the range 1 000 to 9 999 may either:

- translate between the E.218 [i.16] (T)MNC in use in the range 1 000 to 9 999, and the E.212 [i.5] MNC that is subsequently allocated; or
- change the current allocated E.218 [i.16] (T)MNC from the range 1 000 to 9 999 to the E.218 [i.16] (T)MNC in the range 0000 to 0999 that is allocated de-facto with the allocation of the E.212 [i.5] MNC, and so align the MNCs in use.

Annex A: Transmission of numbers and addresses over the Air Interface

A.1 Numbering implementations

This annex provides guidance on where specific dialling algorithms can be used. Dialling algorithms are the rules by which the user entered digits are transmitted over the air interfaces, in particular air interface protocol data units (PDU). The specific air interface PDU used in any specific diagram is labelled air interface address. The information elements "called party SSI", "called party extension", and "external subscriber number" are defined in EN 300 392-1 [i.1], clause 7 and EN 300 392-2 [i.9], clause 14.

Most of the numbering implementations described in this annex contain overview illustrations. The symbols used in those figures should be interpreted according to the following key:

- D = digit;
- B = bit; and
- E = element.

The number in subscript after the symbol indicates the sequential order of the item, e.g. D_1 is the last digit dialled by the user, and B_1 is the most significant bit.

Dashed line in the figures indicates conditional or optional presence of the item surrounded by the line.

A.2 TETRA to TETRA calls Trunked Mode Operation

A.2.1 Private TETRA network

A.2.1.1 Current network

This dialling algorithm applies to calls to the network in which the calling party terminal equipment is registered.

The length of the user dialled digits may vary between the number range supported by the SSI element, i.e. from 1 to 8 within the decimal value range from 0 to 16 777 215. The terminal equipment may contain programmable parameters connected to this algorithm prescribing the expected minimum and maximum length of the user dial string.

NOTE: Very large networks with block allocated SSIs might require all of the SSI number space for subscriber numbers while small TETRA networks may require e.g. only 4 digit subscriber numbers internally. The requirements for the subscriber number length should be included in the numbering plan of each network.

The recommended subscriber number length to be chosen for TETRA network numbering plans is 7, giving the maximum value 9 999 999 decimal, i.e. 98967F hexadecimal.

The user dialled digits are converted to 24 bit called party SSI using true decimal to binary conversion. See figure A.1.

Independently of the network in which the terminal is currently registered, the address used on the air interface should be the called party SSI, when this algorithm is applied and the call is directed to the SSI in the current network.

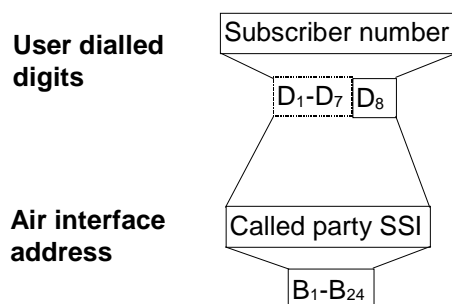

Figure A.1: Overview of home TETRA network algorithm

A.2.1.2 Shortened dialling to Current TETRA network

Shortened dialling to the current TETRA network allows the number of user dialled digits to be reduced when the called subscriber is on the same network as the calling subscriber has subscribed to, or is currently registered on.

The length of user dialled digits is anything from 1 to 8, and they are interpreted as the last digits of the subscriber number. The subscriber's own SSI part of the ITSI is used as a base address, and the last digits of that are replaced by the user dialled digits. The resulting number is then converted to called party SSI using true decimal to binary conversion.

The terminal equipment may contain predefined parameters connected to this algorithm prescribing the expected minimum and maximum length of the user dial string. The maximum length parameter should be set to the maximum length of the subscriber number in the current network. The minimum length parameter may be set according to the user needs, e.g. to disable accidental 1 digit dialling.

The SSI is used as the air interface address, see figure A.2.

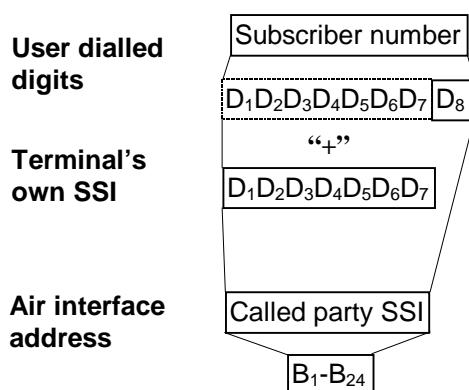

Figure A.2: Overview of shortened dialling algorithm

A.2.1.3 Relative dialling to home TETRA network

Relative dialling to the home TETRA network is intended to shorten the dial strings within a constantly used subscriber's number domain, i.e. for calls to a known user group in the network to which the terminal has subscribed. The migrated terminal will use the SSI, if the called terminal is subscribed to the migrated network. Otherwise the full ITSI is used.

The length of the user dialled digits is anything from 1 to 8, and they are interpreted as the last digits of the subscriber number. A predefined base SSI is used as a base address, and the last digits of that are replaced by the user dialled digits. The resulting number is then converted to called party SSI using true decimal to binary conversion.

The terminal equipment may contain predefined parameters connected to this algorithm prescribing the expected minimum and maximum length of the user dial string.

The overview of the shortened dialling algorithm in figure A.2 applies, provided that terminal's own SSI is replaced by the predefined base SSI and the calling party is his home network.

NOTE: FSSN is an example of relative dialling to a home network.

A.2.1.4 Predefined TETRA network

This dialling algorithm applies to calls to a specific, predefined TETRA network. The network to be accessed is appointed by a predefined MNI value, i.e. MCC and MNC, which is known to the terminal based on subscription. The predefined MNI is unique to this algorithm, i.e. it is selected by the algorithm selection.

The length of the user dialled digits may vary between the number range supported by the SSI element, i.e. from 1 to 8 within the decimal value range from 0 to 16 777 215. The terminal equipment may contain predefined parameters connected to this algorithm prescribing the expected minimum and maximum length of the user dial string.

The recommended length of the user dialled digits is 7.

The user dialled digits are converted to 24 bit called party SSI using true decimal to binary conversion.

The predefined MNI is transferred over the air interface in the "called party extension" information element except when the calling terminal is registered to the predefined network, see [i.9], clause 14.

NOTE: Terminal equipment may apply this algorithm several times for shortened access to several different predefined TETRA networks with different MNIs.

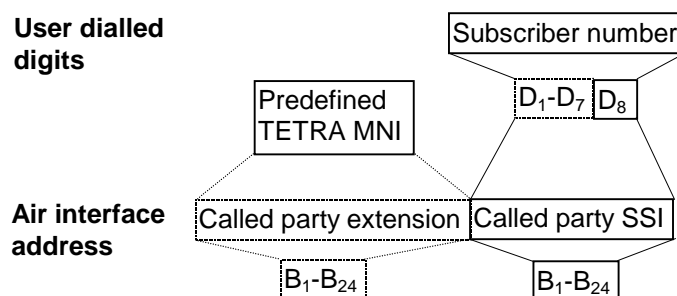

Figure A.3: Overview of predefined TETRA network algorithm

A.2.1.5 Any TETRA network

TETRA networks to be addressed may remain within the same country or they may exist abroad. Using this algorithm to address a domestic TETRA network, the user could dial the TETRA network mobile code and the short subscriber identity. To address a subscriber in a foreign TETRA network user dials the TETRA mobile country code, the TETRA mobile network code and the short subscriber identity.

The TETRA mobile country code, TETRA network code, and the short subscriber identity are encoded individually.

The TETRA mobile country code is a 3 digits number defined for each country. The TETRA mobile code is converted into 10 bit (T)MCC. For the values and encoding of the TETRA mobile country code, see EN 300 392-1 [i.1], clause 7.

The TETRA mobile network code, i.e. the operator code is a 4 digit number. The TETRA mobile network code is converted into a 14 bit MNC using true decimal to binary conversion.

If the user has addressed a subscriber in a domestic network by dialling the TETRA mobile network code and the short subscriber identity only, then the (T)MCC is the (T)MCC part of the terminal's own ITSI address.

This algorithm has a predefined parameter for the absolute number of digits in the short subscriber identity. The recommended predefined value for the short subscriber identity length is 7 digits. The subscriber number is converted into 24 bit called party SSI using true decimal to binary conversion.

NOTE 1: The predefined short subscriber identity length parameter should be set according to the maximum the short subscriber identity length used in the TETRA networks to be accessed using this algorithm. Addressing networks with a shorter subscriber identity than appointed by the parameter value, requires the user to dial the appropriate amount of leading zeros in front of the actual the short subscriber identity. This is necessary to achieve the absolute length defined by the parameter so that the terminal may interpret the whole dial string correctly.

The user dialled digits are interpreted in the following way:

- 1) the number of digits defined by the short subscriber identity length parameter at the end of the dial string;
- 2) the preceding four digits, if present, as the TETRA mobile network code;
- 3) the remaining three digits, if present, as the TETRA mobile country code.

The (T)MCC and (T)MNC, i.e. MNI, are transferred over the air interface as the called party extension element, see [i.9], clause 14.

If the user dialled MNI is the same as the MNI of the current network, then the air interface address used should be the called party SSI only.

If the user dialled MNI is not the same as the MNI of the current network, then the air interface address used should be called party SSI with the called party extension containing the user dialled MNI.

NOTE 2: This dialling algorithm may also be used to address subscribers inside the current TETRA network.

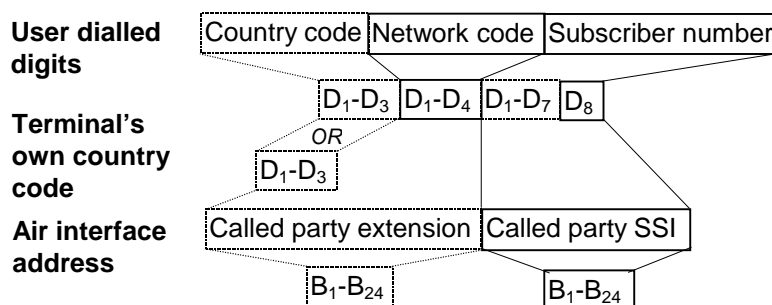

Figure A.4: Overview of any TETRA network algorithm

A.2.1.6 Short number dialling

The user may use network specific short numbers to access subscribers within TETRA domain or in other domains. The knowledge of the Short Number Address (SNA) number allocation and values is based on subscription. The final called party numbers are stored in the terminal's current network. The SNA are transferred upon migration to the visited network, if supplementary service SS-SNA is supported there. The functionality for SS-SNA is defined in ETS 300 392-10-7 [i.7].

The 1 to 3 digit user dial string are transferred over the air interface in the called party short number address element. The dial string is converted into 8 bit short number address using true decimal to binary conversion. The element encoding is defined in EN 300 392-2 [i.9], clause 14.8.6.

NOTE: The values allowed for the SNA are 0 to 255 decimal.

Independently of the network in which the terminal is currently registered, the address used on the air interface should be the called party SNA when this algorithm is applied. The network the terminal is currently registered in needs to support SS-SNA for the calling terminal otherwise the call will fail.

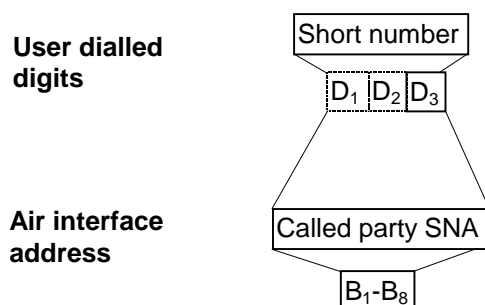

Figure A.5: Overview of short number dialling algorithm

A.2.1.7 Group call addressing

The called party SSI information element in the Air interface signalling shown in figures A.1, A.2, and A.3 above could contain the GSSI of a talk-group that is being called.

If the home network of the called talk-group is not the current network, then it is addressed using its full 48-bit GTSI.

In this case, the Called Party extension information element of the air interface signalling will contain the MNI part of the talk-group's GTSI, with its GSSI being transported in the called party SSI field.

A.2.2 Public TETRA networks

A.2.2.1 E.164 domain

For accessing an E.164 [i.4] gateway connected to a TETRA network, the user may dial up to 24 digits, which are transferred over the air interface in the external subscriber number element. The element encoding is defined in EN 300 392-2 [i.9], clause 14.8.20.

NOTE 1: 24 digits is the maximum capacity of the "external subscriber number" information element in the TETRA signalling [i.9].

The called party SSI address used should be the PREDEF_E164 (see annex D), unless there are other SSI or ITSI values that are dedicated in a specific network for E.164 [i.4] access and known to the terminal based on subscription. All the TETRA networks supporting E.164 [i.4] domain access should support at least PREDEF_E164 SSI for interworking purposes.

The called party extension, i.e. MNI, may be used to address the E.164 [i.4] domain in a specific network.

If the MNI of the E.164 [i.4] gateway ITSI does not equal the MNI of the current network, then it is transferred over the air interface in the called party extension information element.

If the called party extension is absent, then the E.164 [i.4] gateway addressed is considered to be the one in the terminal's current network.

If the network does not support the E.164 [i.4] gateway, then it should reject the call.

NOTE 2: Terminal equipment may apply this algorithm several times with different MNI or SSI values to allow user access to E.164 [i.4] network via different gateways.

The overview of PABX algorithm applies, provided that the E.164 [i.4] gateway SSI and E.164 [i.4] gateway MNI are used instead of corresponding PABX addresses, as illustrated in figure A.6.

NOTE 3: TETRA subscribers may also be addressed using the E.164 [i.4] dialling if they have been allocated an E.164 [i.4] number.

The predefined E.164 [i.4] gateway MNI and E.164 [i.4] GW SSI address values may be stored on a Subscriber Identification Module (SIM), see EN 300 812 [i.13].

A.2.2.2 ISDN

For accessing an Integrated Services Digital Network (ISDN) gateway connected to a TETRA network, the user may dial up to 24 digits, which are transferred over the air interface in external subscriber number element. The element encoding is defined in EN 300 392-2 [i.9], clause 14.8.20.

ISDN dial strings are defined in ITU-T Recommendation E.331 [i.6].

NOTE 1: Using ISDN gateway for voice calls implies digital connection instead of analogue connection as is to be expected using the E.164 [i.4] gateway, see annex E.

The called party SSI address used is always the PREDEF_ISDN, see annex D.

The called party extension, i.e. MNI, may be used to address the ISDN gateway in a specific network.

If the MNI of the ISDN gateway ITSI does not equal the MNI of the current network, then it is transferred over the air interface in the called party extension element.

If the called party extension is absent, then the ISDN gateway addressed is considered to be the one in the terminal's current network.

If the network does not support the ISDN gateway, it should reject the call.

The overview of PABX algorithm applies, provided that ISDN gateway SSI and ISDN gateway MNI are used instead of corresponding PABX addresses, as illustrated in figure A.7.

NOTE 2: A terminal equipment may apply this algorithm several times with different MNI values to allow user access to ISDN network via different gateways.

A.2.2.3 Group call addressing

The addressing in clause A.2.1.7 applies.

A.3 TETRA to TETRA Direct Mode Operation

A.3.1 DMO individual call

Direct Mode Operation (DMO) only supports the use of ITSI and SSI dialling. Short form dialling in which the SSI or ITSI is created by the expansion of a shorter number from within the terminal is at the discretion of the terminal manufacturer. The call set up process converts destination SSI to a full 48 bit ITSI. Terminals which do not share the same MNI are therefore accessible.

DMO Gateways support the transmission of ITSIs such that terminals on the Trunked Mode network using SSI dialling and ITSI dialling may contact a Direct Mode terminal. They also permit Direct Mode terminals to contact terminals on the trunked network using the ITSI or SSI of the target terminal. If an ISI is implemented between two networks then a gateway will permit a Direct Mode terminal to either call or be called by terminals on the connected network.

A.3.2 DMO group calls

Groups are identified in DMO by their full 48 bit GTSI.

Groups may support terminals from more than one network, or from more than one country. The terminals will send the full GTSI of the destination address.

A.4 TETRA to TETRA migration

The dialling algorithms in clause A.2.1 should apply.

A.5 TETRA to public network interworking

A.5.1 Description 1 - SwMI directly connected to the PSTN

The dialling algorithms in clause A.2.2 should apply.

A.5.2 Description 2 - via PABX

A.5.2.1 PABX

For accessing a PABX exchange connected to a TETRA network, the user may dial up to 24 digits that are transferred over the air interface in the external subscriber number element. The element encoding is defined in EN 300 392-2 [i.9], clause 14.8.20.

NOTE 1: The maximum size of the external subscriber number information element of the TETRA signalling is limited to 24 digits, refer to EN 300 392-2 [i.9].

The air interface address used is a predefined ITSI address that is dedicated in a TETRA network for accessing a PABX and known by the terminal equipment based on subscription. The PABX gateway may therefore be located in a network other than the terminal's current network.

If the PABX gateway is located in the terminal's current network, as appointed by the MNI part of the predefined PABX ITSI address, then the air interface address used is always the SSI only.

If the PABX gateway is located in another network than the terminal's current network, then the PABX gateway's full ITSI address is always transferred over the air interface as called party SSI and called party extension element.

If the network is unable to route the call to the network addressed by the PABX gateway MNI (when present) or if it otherwise finds the address or dial string erroneous, then it should reject the call.

NOTE 2: The PABX algorithm may be applied to access any suitable private telecommunication network connected to a TETRA network.

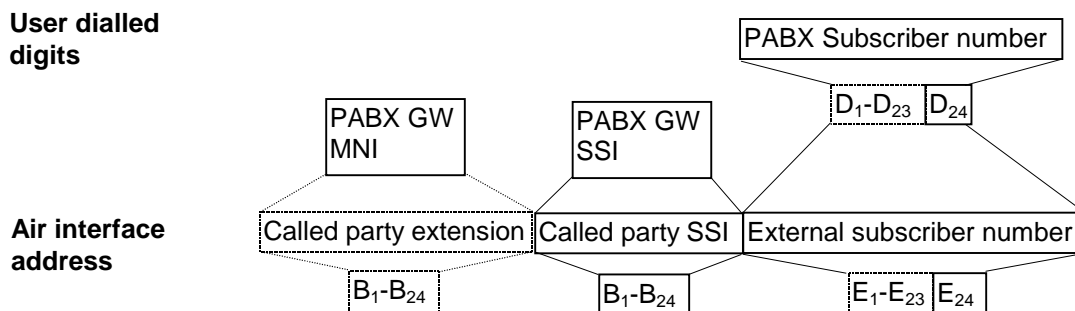

Figure A.6: Overview of PABX algorithm

The predefined PABX GW MNI and PABX GW SSI address values may be stored on a Subscriber Identification Module (SIM), see EN 300 812 [i.13].

A.6 Summary of address exchange over the air interface

The usage of EN 300 392-2 [i.9] PDU information element's contents defined in different numbering implementations in clause A.1 are summarized in table A.1.

Table A.1: Summary of air interface information element's contents

Dialling algorithm	Called party SSI	Called party extension	Called party short number address	External subscriber number
PRIVATE TETRA NETWORK				
Home Network Dialling	User dialled TETRA subscriber number	N/A	N/A	N/A
Shortened dialling to current TETRA network	Terminal SSI + user dialled short TETRA subscriber number	N/A	N/A	N/A
Predefined TETRA network	User dialled TETRA subscriber number	Predefined TETRA MNI <> Current network MNI	N/A	N/A
Relative Dialling to the Home TETRA network.	SSI, e.g. FSSN	N/A or (MNI of Home Network <> Current network MNI)	N/A	N/A
Any TETRA network	User dialled TETRA subscriber number	(User dialled MNI <> Current network MNI) or ((Terminal's (T)MCC + User dialled (T)MNC) <> Current network MNI) or not present	N/A	N/A
Short number dialling	N/A	N/A	User dialled short number.	N/A
Group Call Addressing	GSSI	N/A or (MNI <> Current network MNI)	N/A	N/A
PUBLIC TETRA NETWORK				
E.164 [i.4]	PREDEF_E164 or dedicated SSI in a network that is known by the terminal equipment based on subscription	N/A or (MNI <> Current network MNI)	N/A	User dialled E.164 [i.4] number
ISDN	PREDEF_ISDN	N/A or (MNI <> Current network MNI)	N/A	User dialled ISDN number
Group Call Addressing	GSSI	N/A or (MNI <> Current network MNI)	N/A	N/A

Dialling algorithm	Called party SSI	Called party extension	Called party short number address	External subscriber number
TETRA TO TETRA DMO				
DMO Individual Call	User dialled TETRA subscriber number	User dialled MNI or Terminal MNI	N/A	N/A
DMO Group Call	User dialled or selected TETRA GSSI	User dialled or selected MNI of GTSI	N/A	N/A
TETRA TO TETRA MIGRATION				
As per PRIVATE TETRA NETWORK above				
TETRA TO PUBLIC NETWORK MIGRATION				
PABX	Dedicated SSI in a network that is known by the terminal equipment based on subscription	N/A or (Gateway MNI <> Current network MNI)	N/A	User dialled PABX number
E.164 [i.4] Domain	PREDEF_E164 or dedicated SSI in a network that is known by the terminal equipment based on subscription	N/A or (Gateway MNI <> Current network MNI)	N/A	User dialled E.164 [i.4] number
ISDN	PREDEF_ISDN	N/A or (Gateway MNI <> Current network MNI)	N/A	User dialled ISDN number
NOTE: <> means "not equal to".				

A.7 Data services

The Numbering algorithm implementations defined in clause A.2 may be applied to TETRA data services employing TETRA air interface address exchange, e.g. Short Data Service (SDS) messages, ISDN data, circuit mode data, when the destination address is to be selected using the terminal equipment's MMI. Service selection may be connected to the algorithm selection but it does not depend on the dialling algorithm used. Therefore the service selection is outside the scope of the present document.

NOTE: The data connections are normally established using ancillary equipment connected to the TETRA terminal, and both destination address selection and numbering used are selected directly by a specific data application. In this case the destination address, i.e. the subscriber number, is invisible to the user. For the specification defining the interface for these data equipments, see EN 300 392-5 [i.12].

A.8 Special numbers

In addition to the numbering scheme described in clauses A.2 and A.3, a TETRA terminal may support one or more special user visible numbers, that bypass the selection of dialling algorithm and the normal allocation of addresses in the network, as seen by the user's point of view.

A predefined user dial string, i.e. a special number, is mapped to a predefined, valid air interface address. When the user has dialled a special number, the corresponding predefined air interface address is used instead of the user dial string on the air interface. The combination of the air interface address elements used should comply with one of the numbering implementations in clause A.1.

NOTE 1: The application of these numbers would be, for example, to provide a method of unifying some of the TETRA user numbers with well-established numbers in other systems. For example user dialled number 118, which is the national E.164 [i.4] directory enquiry number in Finland, could be defined to apply the "E.164 [i.4] domain" dialling algorithm with external subscriber number value 118 to unify the user dial strings in both networks.

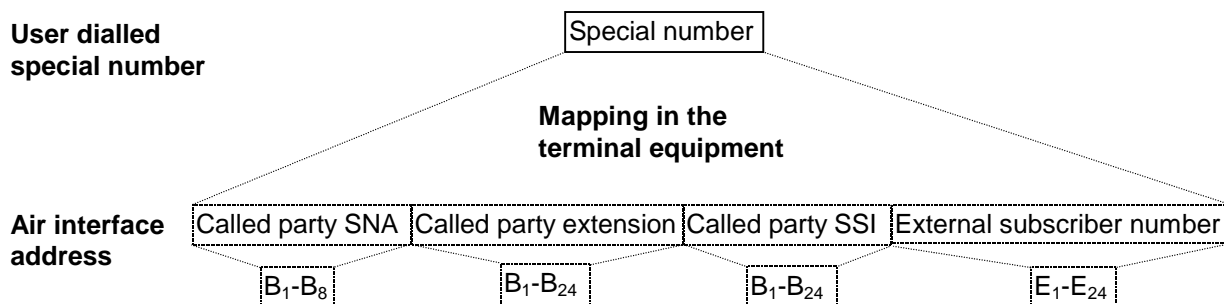

Figure A.7: Overview of special numbers

NOTE 2: User dial string 112 should be reserved. This is the harmonized number in the European Community for the emergency service, see Council Decision 91/396/EEC [i.11]. Similarly, other service numbers could be harmonized in the future on a national or international basis.

The special numbers should be interpreted by terminal equipment so that the algorithm selection takes place only after the number dialled by the user has been recognized not to be a special number. This applies to the case where algorithm selection is related to the dialled number, as is the case, for example, when leading digit algorithm selection is used.

Annex B: Radio User Number

B.1 Service overview

This annex gives an overview of the Radio User Number (RUN) private numbering plan. The information regarding RUN is contained in the TIP [i.14].

The present document describes the operation of two functions relating to the association of radio users to MSs in TETRA systems.

The first function described is the Radio User Assignment (RUA). This is the process by which a person or function may signal to the SwMI using the SDS service that they are now using a particular MS. The assignment process may also be used as a mechanism for the SwMI to authenticate a radio user by means of an optional radio user PIN.

The second function is the use of the Radio User Number (RUN). The RUN is used to initiate individual communications to, and to identify individual communications from, a radio user. The RUN may be associated with an MS through the radio user assignment process.

NOTE: The requirement for Radio User Assignment (RUA) is SwMI / operator dependent. Some SwMIs / operators do not require this function, in which case the assignment application in the MS is not invoked. The requirements stated in clause B.2 only apply to those SwMIs that require over the air radio user assignment.

B.2 Radio User Assignment

The Radio User Assignment (RUA) process enables a radio user to inform the SwMI that they are now using a particular MS. This notification may either identify the individual or the role of the individual depending on the requirements of the end service.

The assignment message contains a Radio User Identifier (RUI) that can be any of the following:

- a) RUN
- b) FSSN
- c) E.164 [i.4] number / MS-ISDN
- d) Other

For ease of MMI entry it is anticipated that in most cases the RUI will be numeric.

B.3 Radio User Number

The Radio User Number (RUN) forms part of a numbering plan that is independent from ITSI numbering. It is similar to FSSN in that the SwMI manages the translation from RUN to ITSI. However it differs in that it uses gateway signalling utilizing the external number field in order to transmit the called party identity in the U-SETUP PDU and the calling party in the D-SETUP PDU.

An advantage of RUN over FSSN is that it may provide greater flexibility in number allocation, allowing national and potentially even international number plans to be produced. Its disadvantage over FSSN is that it increases signalling overhead in that a RUN gateway ISSI has to be sent over the air interface as well as the RUN in the external number field.

The present document describes the implementation of RUN in relation to Air Interface signalling. However the use of RUN could be extended to other external interfaces outside the scope of the present document. An example is a telephony gateway where the RUN could be used to call a radio user from an external telephony user. Another example where RUN may be used, is in Dispatching system interfaces, where the RUN can be used to initiate individual communications to, and to identify individual communications from, a radio user.

B.4 Information flows

The following clause describes the basic numbering and addressing related information flows that take place in the network. It does not go into great detail, but it aims to provide a simple view of the interactions that take place.

Man Machine Interface (MMI) examples shown are Mobile Station (MS) specific and as such are not mandatory.

The information contained in the arrows in the figures indicating the direction of information flow between the Mobile Station and the Infrastructure should not be taken to mean that this information is actually transmitted over the air interface but simply that it is indicative of the information contained. The information that is indicated can be derived from the information that is sent, e.g. the information at the various levels, such as the MAC address at Level 2, and the information contained in the SwMI.

B.4.1 Mobile Station authentication

Radio terminal authentication is TETRA authentication and is defined in EN 300 392-7 [i.15] and TTR001-17 [i.14]. Additional authentication is required to establish the relationship between the RUN and the ITSI. This is outside of the scope of this annex. The information flows for mobile station authentication are shown in figure B.1.

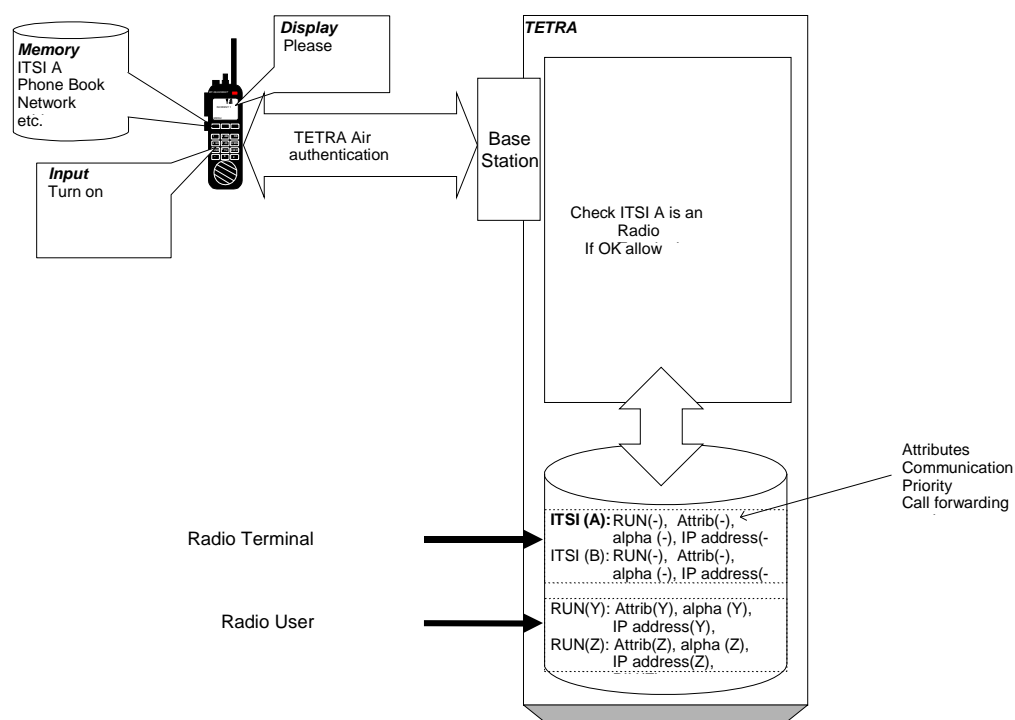

Figure B.1: Information flows for Mobile Station authentication

B.4.2 Radio user authentication

Radio user authentication allows for aliasing. The object of the aliasing service is to provide a means to tie a radio user to a Mobile Station (MS). This enables communications destined for a radio user to reach a specific mobile station and also allows the identification of communications from that mobile station as being from a particular radio user. The process to tie a radio user to a mobile station is termed assignment.

The prime means to achieve assignment is to send an SDS message into the infrastructure carrying the radio user's identity and a PIN for security. Currently the preferred way of identifying a radio user is the RUN, although the use of the Alpha-tag can be considered. The reason that RUN is preferred is due to ease of entry and because it is the prime number used to contact and identify that radio user for point-to-point communications.

The information flows for the user authentication (logon) process are shown in figure B.2.

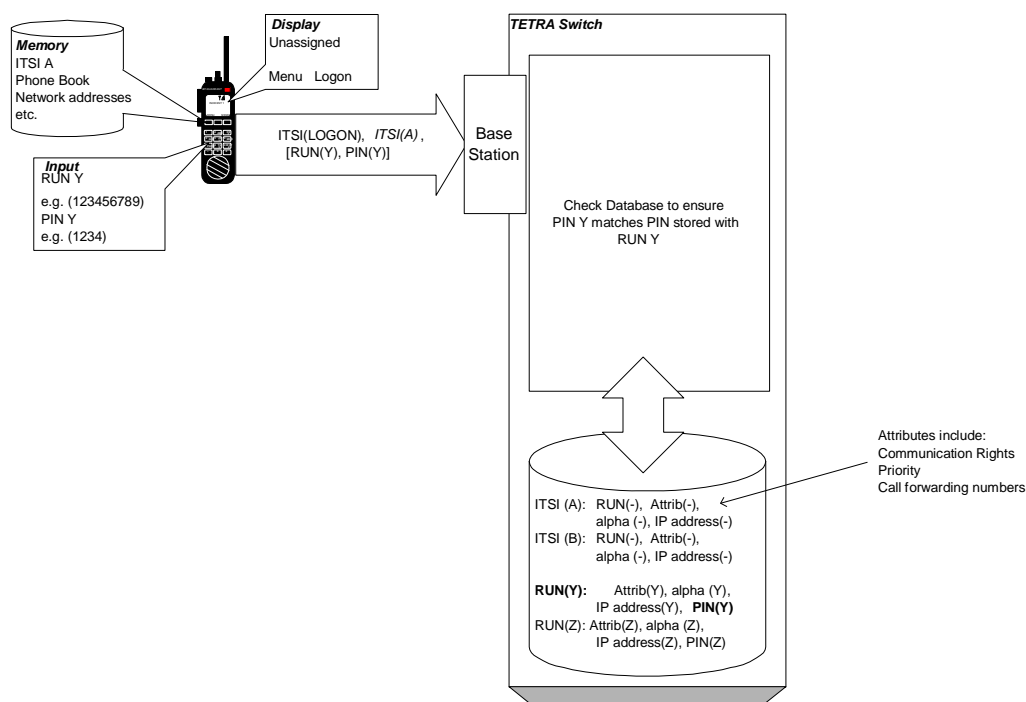

NOTE: CLI shown in italics.

Figure B.2: Information flows for the User Authentication (Logon) process

Upon the receipt of a user authentication message the infrastructure will check to ensure that the radio user and the PIN are valid and, if so, then the infrastructure will complete the assignment process. If the assignment process fails (e.g. if the PIN is incorrect) then a failure message will be returned and the mobile station will retain basic access rights). The information flows involved in the assignment process and the acknowledgement that is sent to the mobile station are shown in figure B.3.

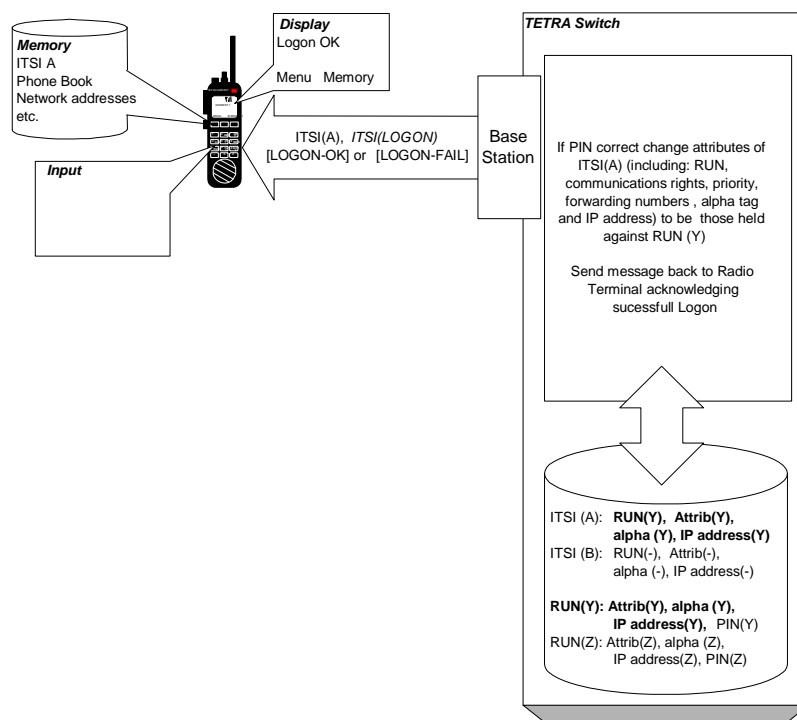

NOTE: CLI shown in italics.

Figure B.3: Information flows for the assignment process

B.4.3 Group communications

Group communications will probably be the most important mode of communications within the operator network especially in the early years. All group communication is implemented by using either the Group TETRA Subscriber Identity (GTSI) or the Group Short Subscriber Identity (GSSI).

Prior to becoming a member of a group the mobile stations and dispatcher terminals need to signal their intent to be a part of the group - this signalling is termed "attachment". Attachment of a mobile station to a group is part of the TETRA air interface standard and it is necessary to ensure that group communications are only sent out on base-stations where group members are active. The mobile station attachment message is signalled using its ITSI. All subsequent group signalling and processing that identifies a particular mobile station also uses the ITSI to ensure fast call set-up.

B.4.4 Group voice communications

Figure B.4 assumes that both the mobile station and the dispatcher terminal have successfully attached to talkgroup 1. The figure shows the basic information flows that take place for a dispatcher originated group "speech item". As with all of the following figures the originator's identity or Calling Line identity (CLI) is shown in italics.

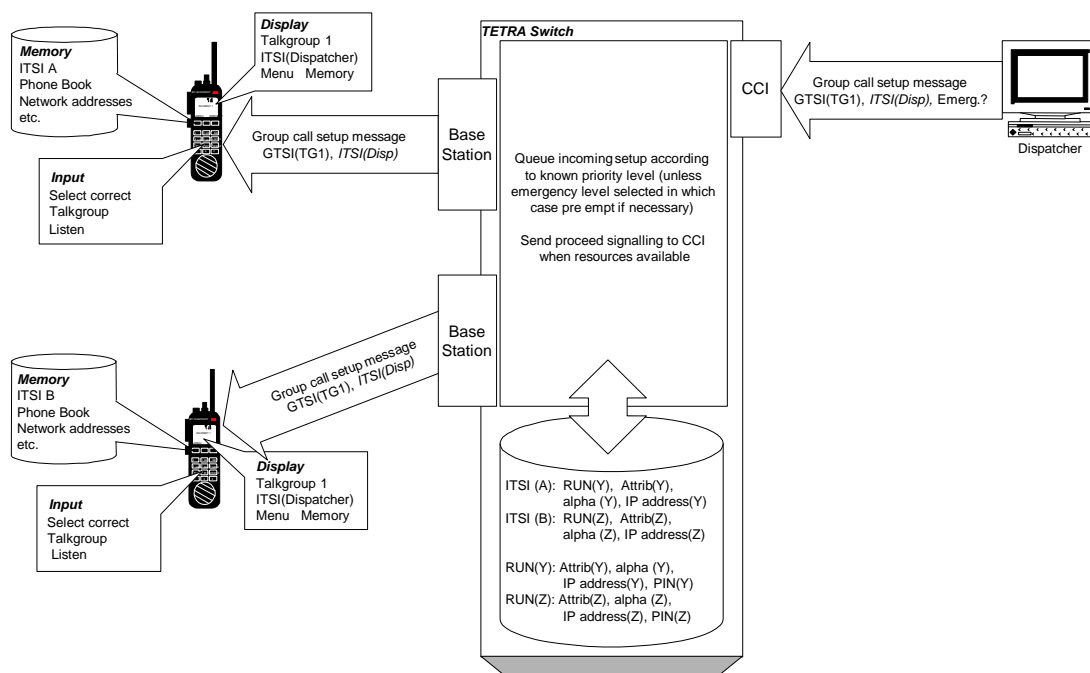

NOTE: CLI shown in *italics*.

Figure B.4: Information flows for a dispatcher originated group "speech item"

For a group "speech item" originating from a mobile station the signalling flows are very similar to those where the call is originated from a dispatcher terminal (see figure B.5). For the dispatcher the CCI will also allow the Alpha-tag currently associated with that mobile station to be displayed (or radio user, if assignment has taken place).

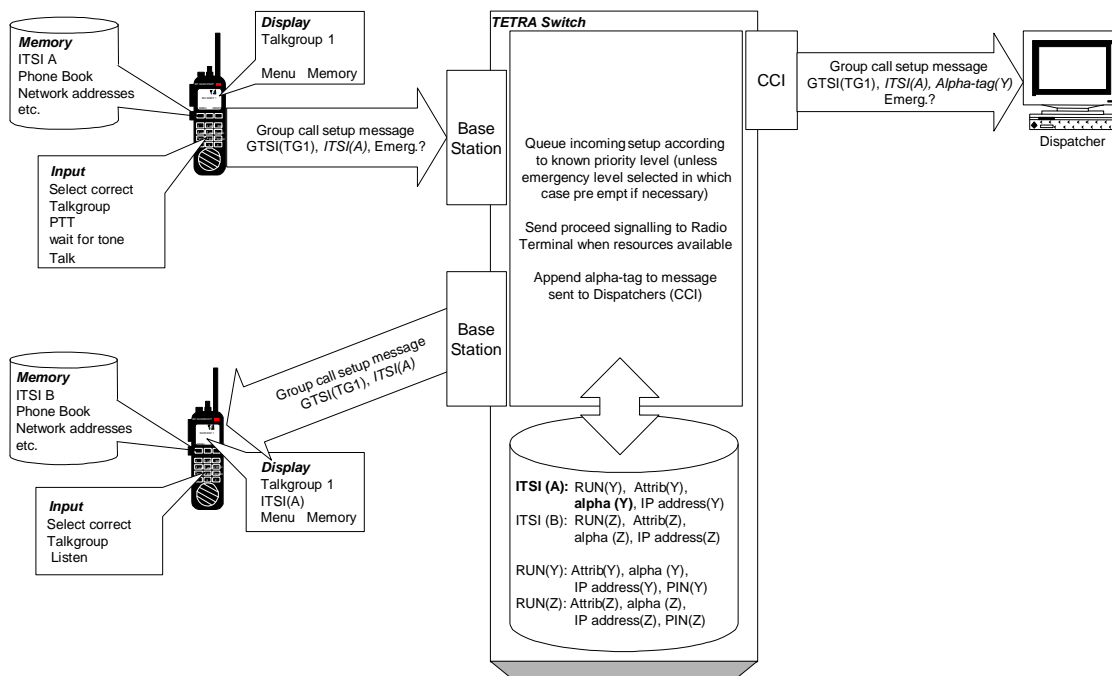

NOTE: CLI shown in *italics*.

Figure B.5: Information flows for a group "speech item" originating from a Mobile Station

B.4.5 Group SDS/status messaging

For group addressed SDS and Status messages the information flows are very similar. For status and type 1 messages the message contents are carried in the original message. For longer messages the mobile station will either be signalled to transmit or receive the addition message contents on the main or a secondary assigned control channel.

The information flows for a group addressed SDS message from a mobile station are shown in figure B.6.

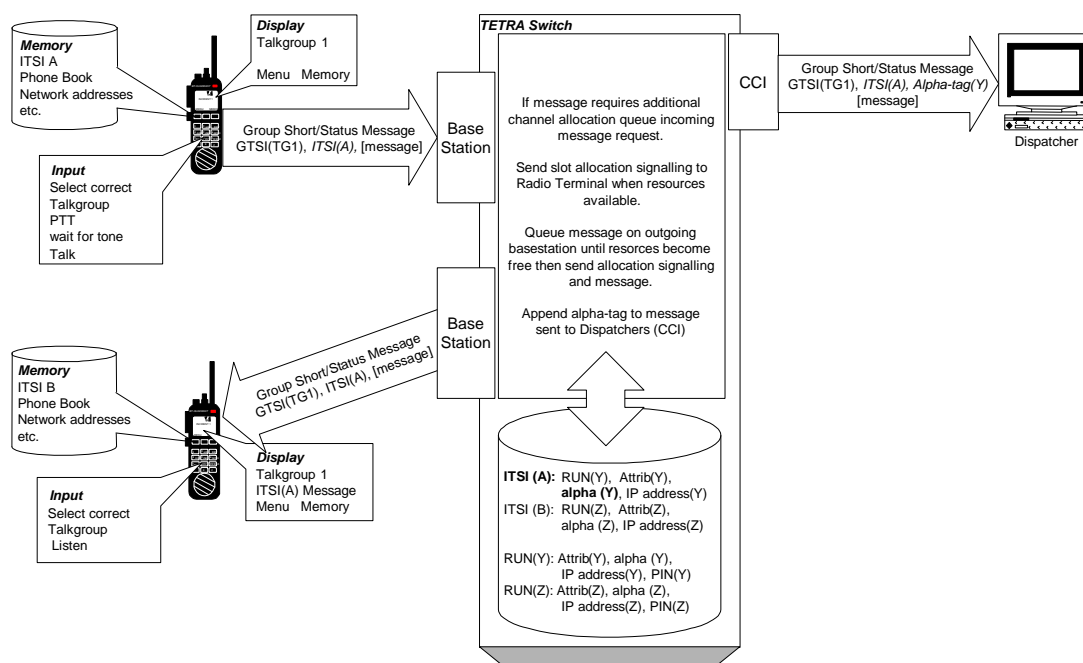

NOTE: CLI shown in italics.

Figure B.6: Information flows for a group addressed SDS Message from a Mobile Station

B.4.6 Mobile station to mobile station communications

B.4.6.1 General

This clause details trunked mode communications between mobile stations without the involvement of a dispatcher.

B.4.6.2 Mobile station to mobile station voice calling

For mobile station to mobile station voice calling there are basically two options. Where the operator has no connection with a network, then an operator can implement ITSI dialling (either full or shortened as described in the dialling plan). Where the operator is connected to the PSTN, then a Private Numbering Plan (PNP) should be used.

The disadvantage of ITSI dialling is that a call is made to a mobile station rather than to a radio user. However the ITSI identifies the mobile station, not the radio user, and in a shared mobile terminal environment that might not be satisfactory.

The information flows associated with ITSI dialling are shown in figure B.7.

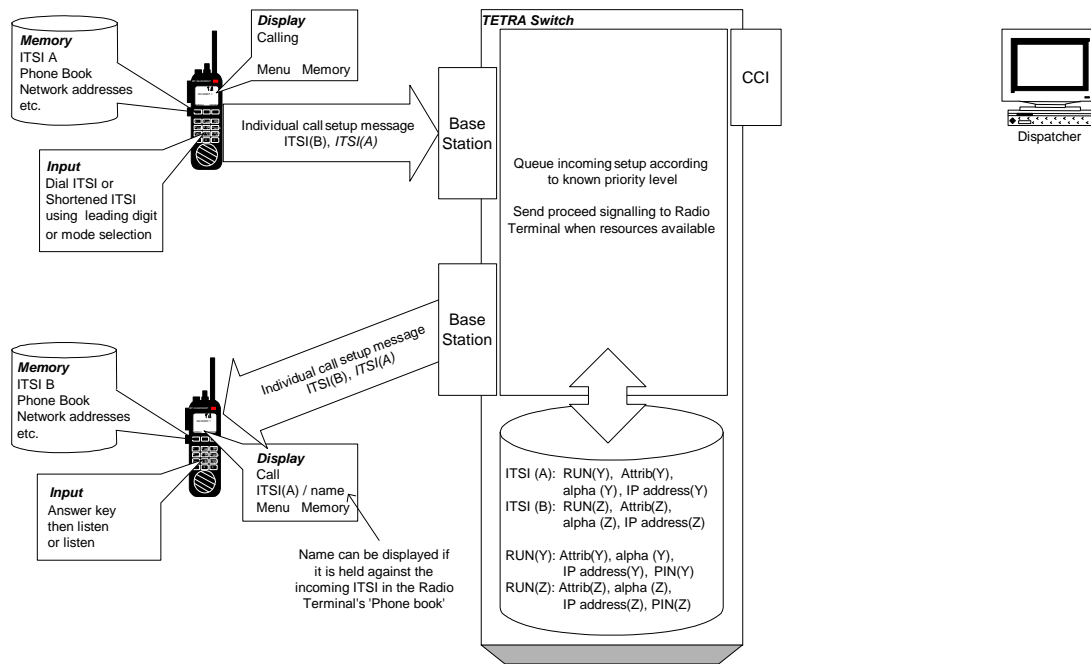

NOTE: CLI shown in italics.

Figure B.7: Information flows associated with ITSI dialling

The second option for mobile station to mobile station calling is really radio user to radio user calling because it uses the RUN (either full or shortened as described in the dialling plan).

By using the RUN (which is always associated with a radio user) the call will be completed to the mobile station to which the radio user is currently assigned.

The added advantage is that if the mobile station is lost then the RUN can be kept even though the mobile station ITSI changes.

The information flows and network translation that takes place is shown in figure B.8.

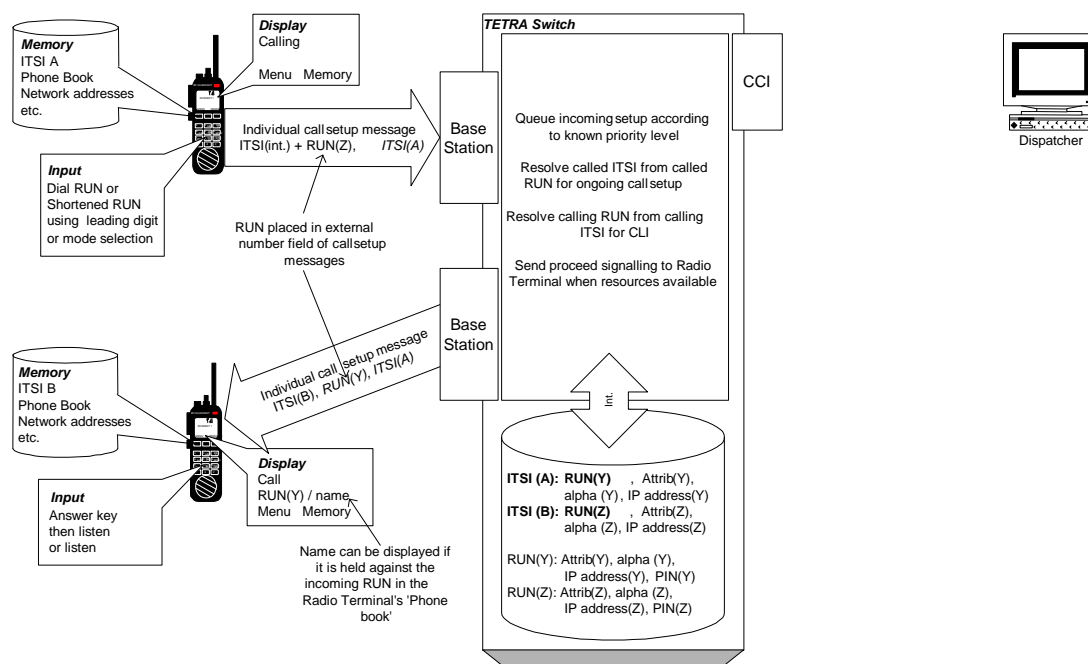

NOTE: CLI shown in italics.

Figure B.8: Information flows and network translation

B.4.6.3 Mobile station to mobile station SDS messaging

The options for sending SDS messages between mobile stations / radio users are the same as for the voice service. This means that both ITSI and RUN addressing are available.

NOTE: Use of RUN for status and short SDS will more timeslots at the air interface than use of SSI or FSSN.

B.4.7 Mobile station - PTN communications

B.4.7.1 Mobile station to PTN voice calling

For calls to an operator's PTN or PBX, the radio user enters the dialling plan digits which are converted into the SSI information element. Following this, the numbers dialled will be placed in the external number field of the call set-up message. At the PTN gateway the called number presented in the ISDN call set-up message will be the number that was in the external number field (it will not contain the dialling plan indicator).

If the operator's PTN requires additional routing digits prior to the PBX terminal number, these will be dialled after the leading digit or mode selection.

CLI presented in the ISDN call set-up message will be the RUN, which will be resolved by the network from the calling ITSI.

The basic information flows for a call from a Mobile Station to a PTN gateway are shown in figure B.9.

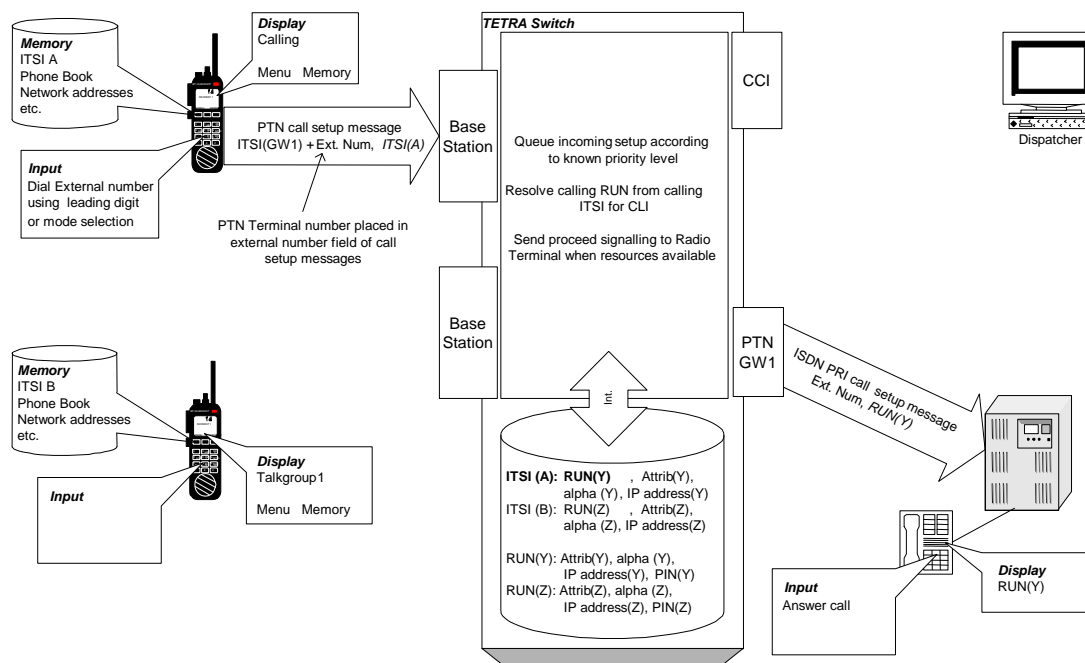

NOTE: CLI shown in italics.

Figure B.9: Information flows for a call from a Mobile Station to a PTN gateway

B.4.7.2 PTN to mobile station calling

For calls from the PTN gateway to a mobile station only one option will be available, that being RUN calling. From the operator network side the PTN gateway will expect to see the full RUN in the ISDN call set-up message. The network will then resolve the correct mobile station to complete the call based upon the current Radio User Assignment (RUA).

If the originating PBX is capable of also sending CLI in the set-up this will be sent to the mobile station in the external number field of the air interface message.

The basic information flows for a call from a PBX terminal to a radio user are shown in figure B.10.

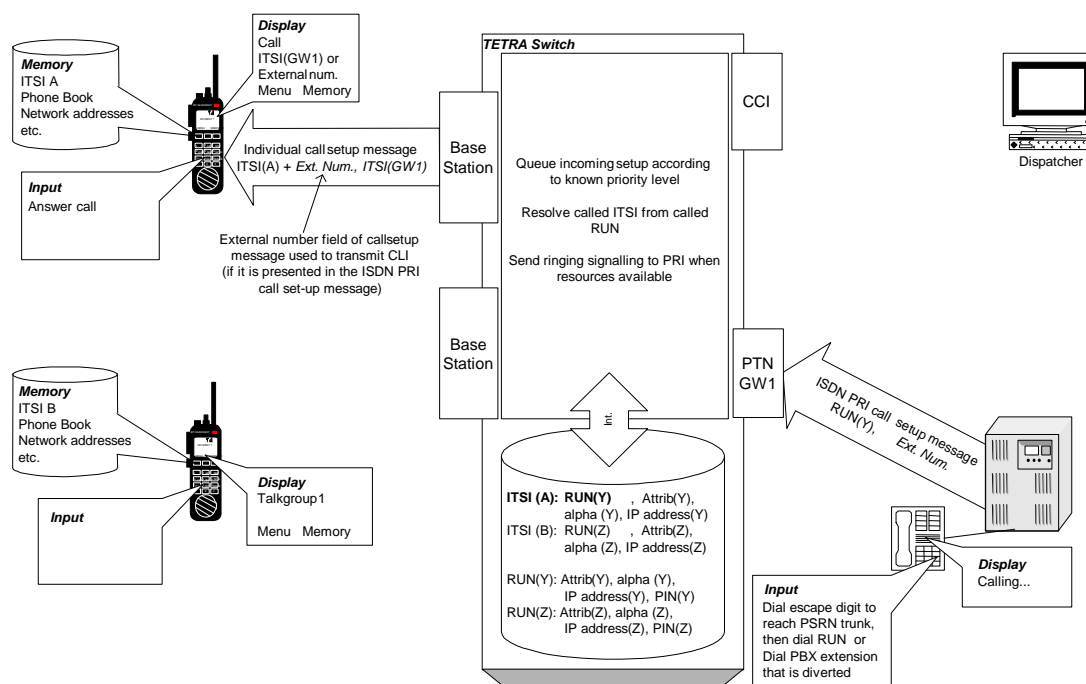

NOTE: CLI shown in *italics*.

Figure B.10: Information flows for a call from a PBX terminal to a radio user

How the PBX creates the ISDN call set-up message is a matter for the network operator, or their PBX provider.

Probably the best way to call from a PBX is to include the operator network PTN gateway trunk in the operator's PBX dialling plan. Ideally to make calling the mobile stations as easy as possible, single digit for routing would be used, although multi-digit routing would be equally valid.

B.4.8 Mobile Station - PSTN communications

B.4.8.1 Mobile Station to PSTN communications

For communications from a mobile station to the PSTN, the radio user just dials the normal PSTN number from the mobile station (if compliant to the dialling plan, otherwise the user may have to make a mode selection first).

For security reasons CLI is displayed as "withheld" at this time.

The information flows are shown in figure B.11.

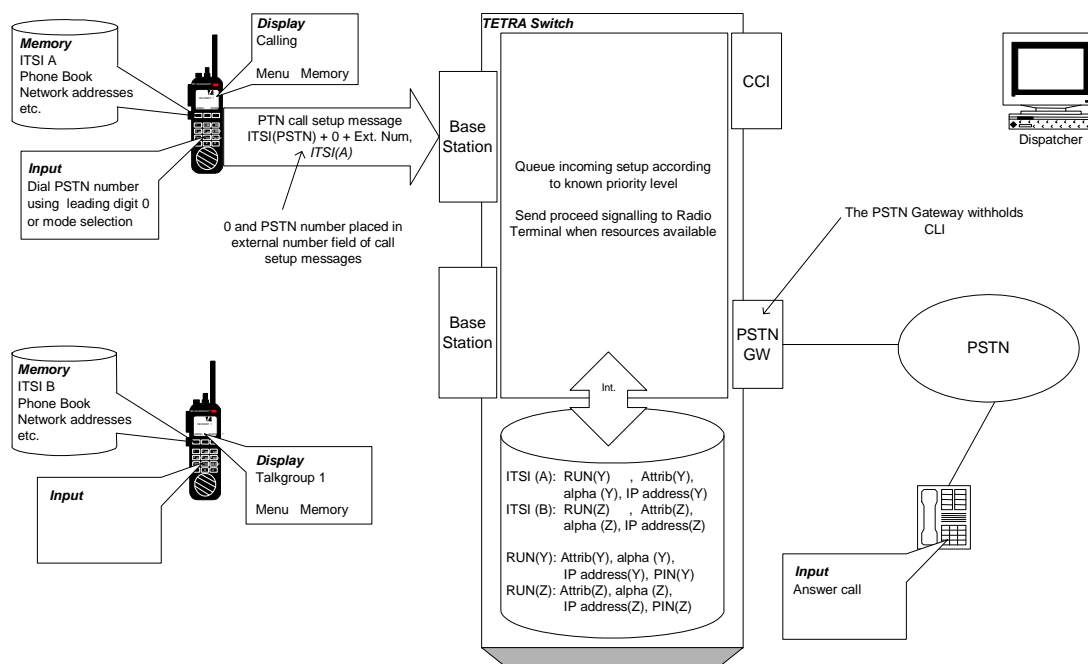

NOTE: CLI shown in italics.

Figure B.11: Mobile Station to PSTN communications

NOTE: The use of the leading digit 0 in the above diagram is for illustrative purposes only. Alternative dialling algorithms could be used and would be dependent upon, for example, the nature of the national dialling plan in use, whether or not it supports local dialling (and so has the digit '0' free) and is called "open", or has full national dialling (where the digit '0' would not be free), and is called "closed".

B.4.8.2 PSTN to mobile station communications

For communications to a mobile station from the PSTN, an MS-ISDN number will be allocated. This MS-ISDN number will be mapped to an RUN by the PSTN gateway for onward transmission through the operator network.

If available from the PSTN the CLI will be forwarded to the mobile station in the external number field.

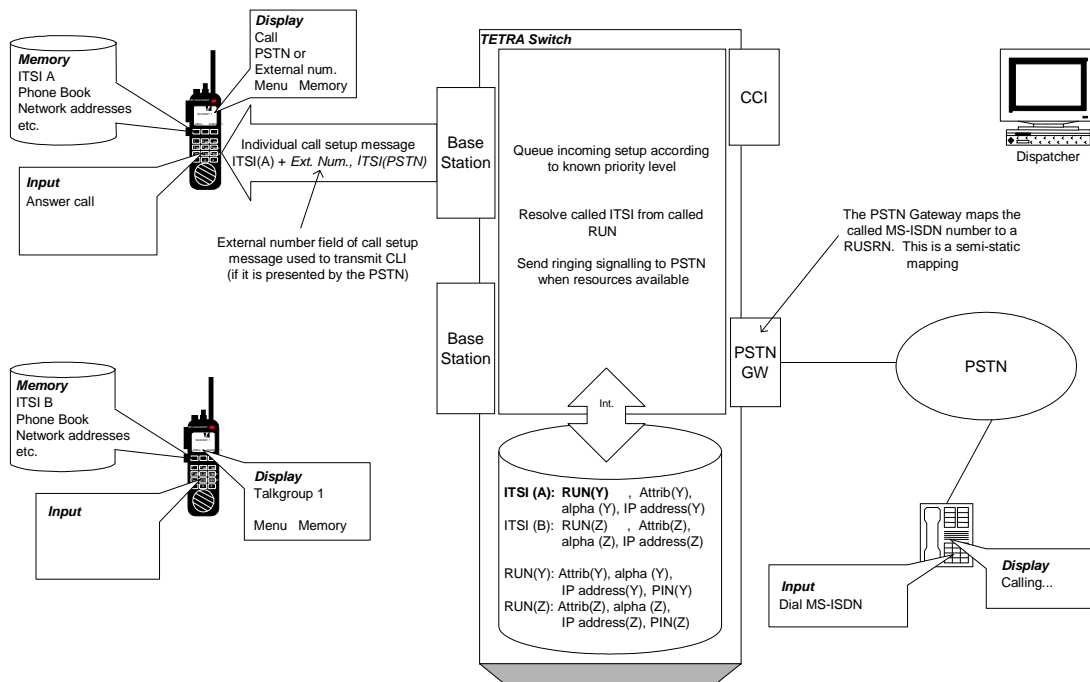

NOTE: CLI shown in italics.

Figure B.12: PSTN to Mobile Station Communications

Annex C: Fleet Short Specific Numbering

C.1 Introduction

C.1.1 Purpose

This annex is to describe the method of operation for Fleet Specific Short Number (FSSN) in TETRA systems. Therefore, the flow diagrams describe a generic SwMI and the alternate responses to signalling that an MS may see. The call control and mobility signalling alone indicate how the MS behaves; there is no need for an MS to recognize a SwMI from manufacturer A or manufacturer B and so behave in a particular way specific to that manufacturer implementation.

C.1.2 Scope

The scope of this annex is constrained to FSSN in the home network. Further details of FSSN can be found in [i.10].

C.2 Fleet Specific Short Number (FSSN)

C.2.1 Protocol specification documents

The FSSN is not defined in the ETSI standards. However, the protocol documents that cover FSSN functionality are in [i.10] which covers signalling and all applicable PDUs.

C.2.2 Service overview

FSSN is an example of a private numbering plan.

FSSNs are dynamic numbers and therefore it is not required to program either the FSSN or any part of it into MSs. An FSSN is stored in the SwMI. That means that FSSNs can easily be changed without re-programming MSs.

An MS user can, using FSSN within its own FSSN domain:

- make individual calls (direct or on/off hook signalling);
- send SDS messages to an individual subscriber;
- send status messages to an individual subscriber.

Normal ISSI addressing and FSSN addressing may be used in the same SwMI simultaneously and even to address the same subscribers, in which case the calling party determines the addressing type by using either ISSI or FSSN dialling.

When the called party SSI is a transposed FSSN, then the calling party SSI should also be presented to the called MS as a transposed FSSN in the following cases:

- as a CPI and TPI in individual calls;
- as a CPI in status messages; or
- as a CPI in SDS messages.

A SwMI may also use an FSSN for the current talking party identification (CPI and TPI) in group calls.

FSSN addresses are unambiguous only within an FSSN domain. Two or more subscribers may have the same FSSN address if they belong to different FSSN domains. Thus FSSNs alone cannot be used for dialling between FSSN domains (either an ISSI or MS-ISDN dialling may be used in this case).

FSSNs cannot be used to identify the called party in group calls (GSSI is used).

C.2.3 Needed number conversions

FSSN addressing uses the SSI address space. A single pre-defined value is used as a base address for FSSNs and the user dialled numbers are relative to that base address. To facilitate the conversion between FSSN and transposed FSSN, the recommended FSSN base SSI should be a multiple of 1 000 000. The default value for the FSSN base SSI is 15 000 000. The same FSSN base SSI is programmed into the SwMI and into all MSs that use FSSN addressing.

C.2.4 Call to FSSN

C.2.4.1 Individual call

When the SwMI receives the U-SETUP PDU, it searches for the SSI that maps to the dialled FSSN (or a combination of dialled FSSN and calling party SSI) and completes the call set-up. The calling subscriber's number should always be displayed in the same format as the dialled number. If the A-subscriber dials an FSSN then the A-subscriber's FSSN is shown to the B subscriber (the B subscriber MS does this by subtracting the FSSN base SSI from the transposed FSSN presented to it by the SwMI).

C.2.4.2 Group call

An FSSN may be used for CPI and TPI in a TETRA group call. In a system where FSSNs are required for dialling and addressing, the calling party address SSI in the D-SETUP PDU will be the transposed FSSN of the group member requesting the call. In addition, the transmitting party address SSI in subsequent D-TX-GRANTED PDUs will be the transposed FSSN of the group member granted permission to transmit.

If the talking party does not have an FSSN then the ISSI may be used. If the group spans more than one FSSN domain, it is not reliable to use FSSNs for TPI in a group call, since the FSSNs are unique only inside a single FSSN domain.

C.2.5 Two tier system

It is possible for the FSSN to be partitioned into a Fleet ID and a Member ID. However, knowledge of any such partitioning is not required in the MS, only in the SwMI. This would enable dialling and addressing within a single fleet of MSs and also between multiple fleets, provided that all of the fleets were members of the same FSSN domain. For example, less than 6-digit dialling could be interpreted as intra-fleet, and 6-digit dialling inter-fleet. Thus the valid range for intra-fleet FSSNs would be 0 to 99 999, and for inter-fleet FSSNs 100 000 to 999 999, giving 900 000 possible addresses within a single FSSN domain.

If an intra-fleet call was made from member MM_1 to member MM_2 of fleet FFFF, it is only necessary to dial MM_2 . The called party SSI in the U-SETUP PDU would be 15 000 0 MM_2 . The SwMI adds the Fleet ID in order to generate the full 6-digit FSSN, before the called party ITSI that maps to FFFF MM_2 could be found.

Even if in an intra-fleet call, FFFF MM_2 were dialled, the SwMI should still use 15 000 0 MM_1 to identify the calling party.

If the call was inter-fleet, from member MM_1 in fleet FFF F_1 to member MM_2 in fleet FFF F_2 the called party SSI in the U-SETUP PDU would be 15 FFF F_2MM_2 and the calling party SSI in the D-SETUP PDU 15 FFF F_1MM_1 .

In either case, the calling party FSSN is used for CLI. The process of adding and removing the Fleet ID should remain a SwMI function, so that the MS does not need to know its Fleet ID or Member ID.

C.3 Signalling examples

Dashed flows are used to indicate PDUs that are optional in the given scenario.

C.3.1 Individual call using FSSN

The individual FSSN call set-up from an MS to another MS is identical to that for an individual call. If an MS user dials an FSSN, e.g. X XXX, where X XXX is B-subscriber's FSSN, the called party SSI element value in the U-SETUP PDU is 15 00X XXX as shown in figure C.1. 15 000 000 is the pre-defined base SSI. In the D-SETUP PDU, the calling party SSI element value is 15 00Y YYY, where Y YYY is A-subscribers FSSN. The B-subscriber is addressed with the SSI at layer 2.

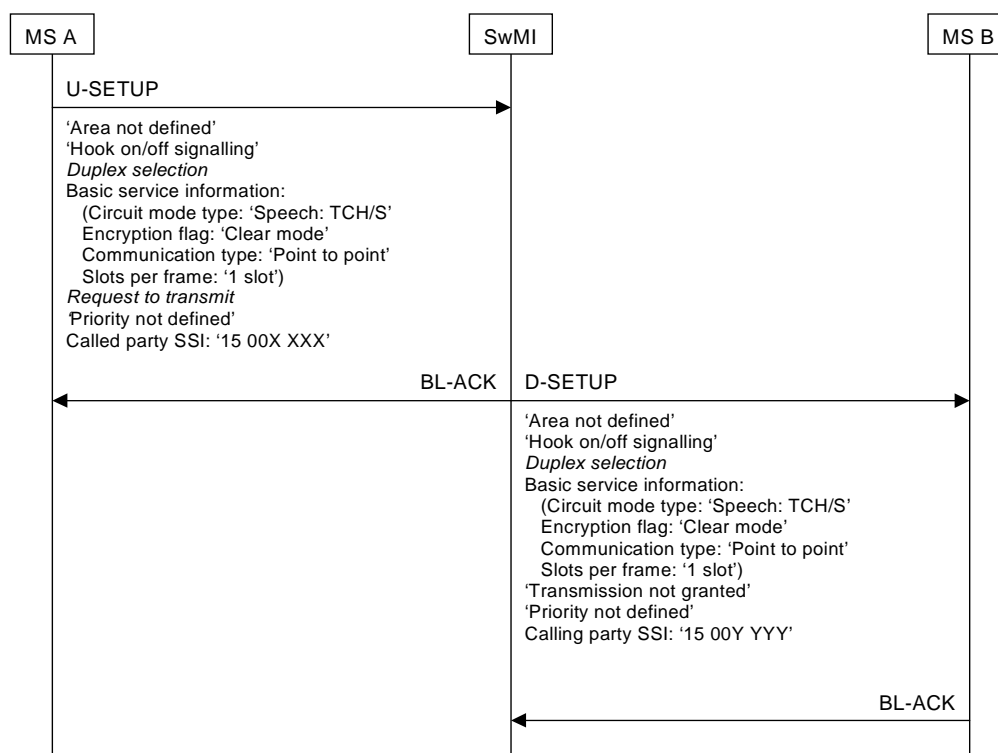

Figure C.1: Individual call set-up using FSSN

NOTE: The dialled FSSN, X XXX, serves as an example, and could be anything from 1 to 6 digits in length.

C.3.2 Group call within single FSSN domain using FSSN for CPI/TPI

In a group call, the Called Party SSI is always a GSSI and cannot be an FSSN. If all group members belong to the same FSSN domain, CPI and TPI can be an FSSN. If some group members belong to a different FSSN domain, CPI and TPI can be either an ISSI, MS-ISDN or empty. The A-subscriber selects the group and the call is addressed to the GSSI. The CPI seen by the B-subscribers is Y YYY, which is A-subscriber's FSSN.

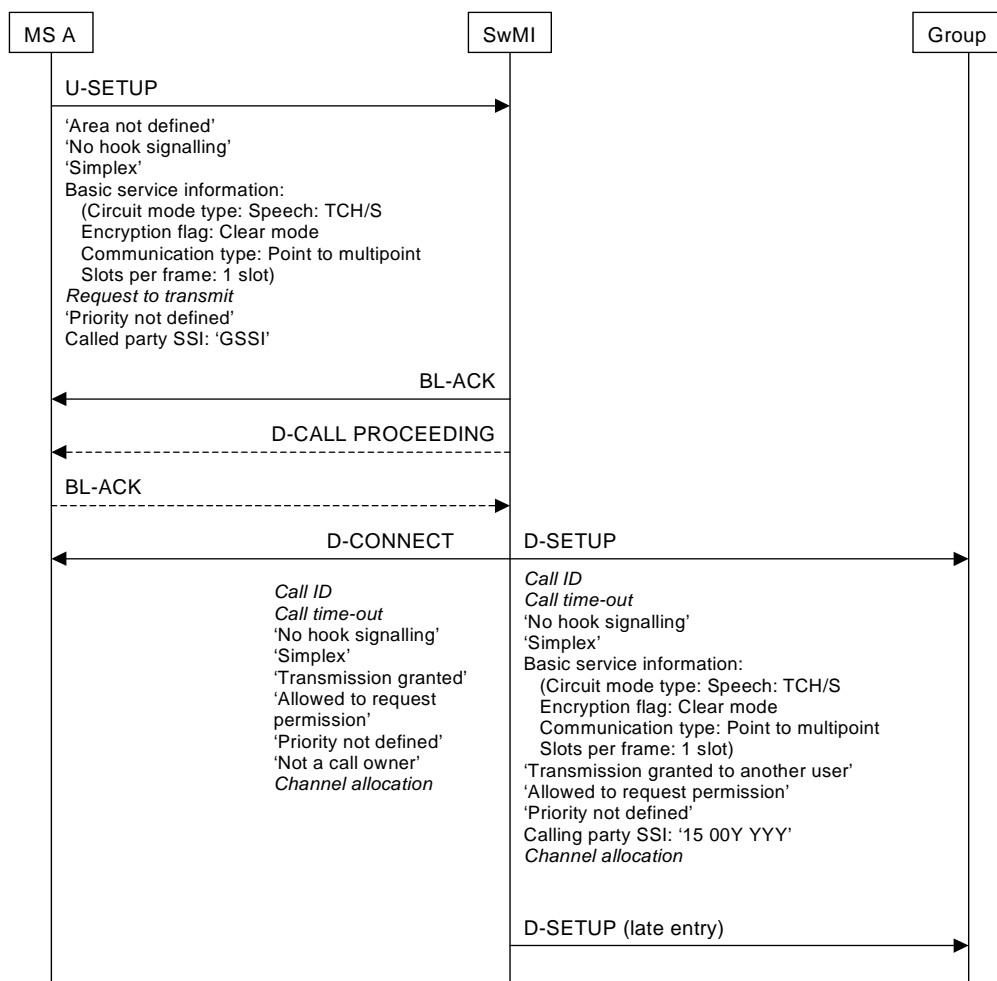

Figure C.2: Group call within single FSSN domain using FSSN for CPI and TPI

NOTE: The calling party's FSSN, Y YYY, serves as an example, and could be anything from 1 to 6 digits in length.

C.3.3 Group call maintenance using FSSN for TPI

Whenever the member of a group (MS Y) is granted permission to transmit, the TPI seen by all members of the group is Y YYY, which is Y-subscriber's FSSN.

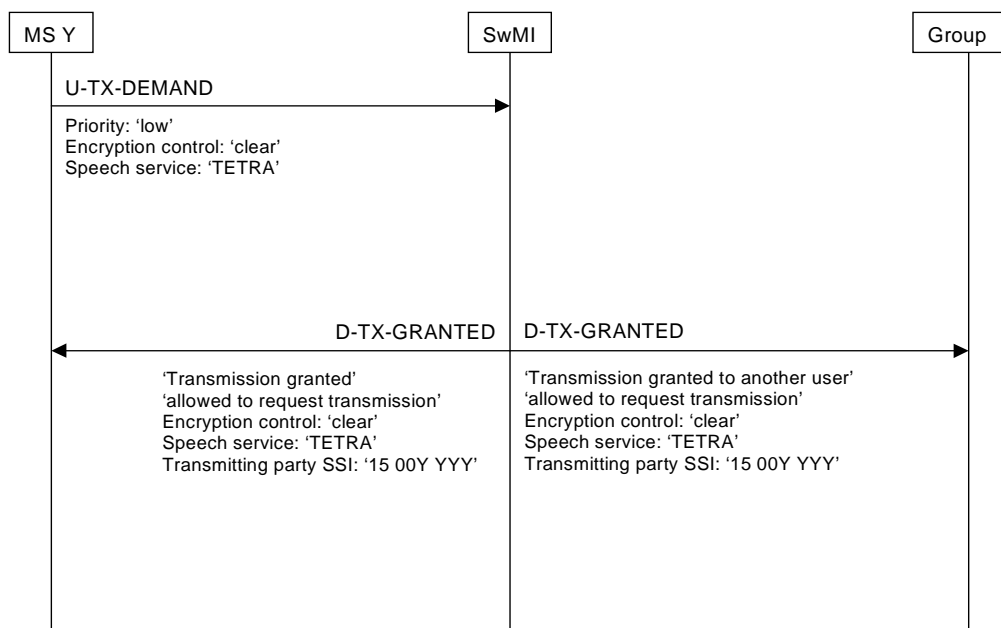

Figure C.3: Group call maintenance, FSSN used for TPI

NOTE: The talking party's FSSN, Y YYY, serves as an example, and could be anything from 1 to 6 digits in length.

C.3.4 Individually and group addressed status messages

The signalling case of an A-subscriber sending a pre-coded status message to B-subscriber using an FSSN is presented in figure C.4. An FSSN is used as the CPI. A-subscriber's FSSN is Y YYY and B-subscriber's X XXX. FSSN may also be used as the CPI in group addressed status messages.

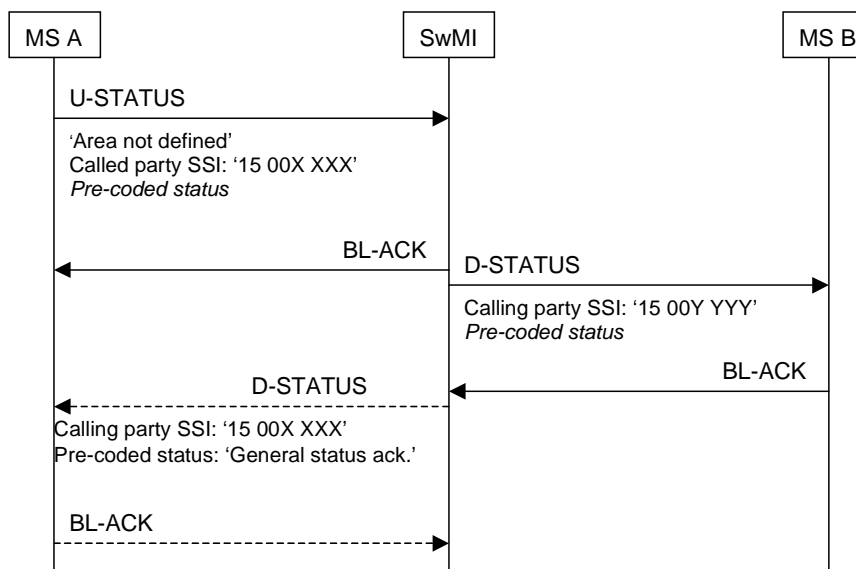

Figure C.4: Individually addressed status message

NOTE 1: The FSSNs X XXX and Y YYY, serve only as an example, and could be anything from 1 to 6 digits in length.

NOTE 2: D-STATUS and BL-ACK are sent only if acknowledgement is defined to be sent by the SwMI (acknowledged status) using the nominated Status value.

C.3.5 Individually and group addressed SDS text messages

The signalling case of individually addressed SDS text messages with short acknowledgement is presented in figure C.5. A-subscriber's FSSN is Y YYY and B-subscriber's X XXX. FSSN may also be used as the CPI in group addressed SDS text messages.

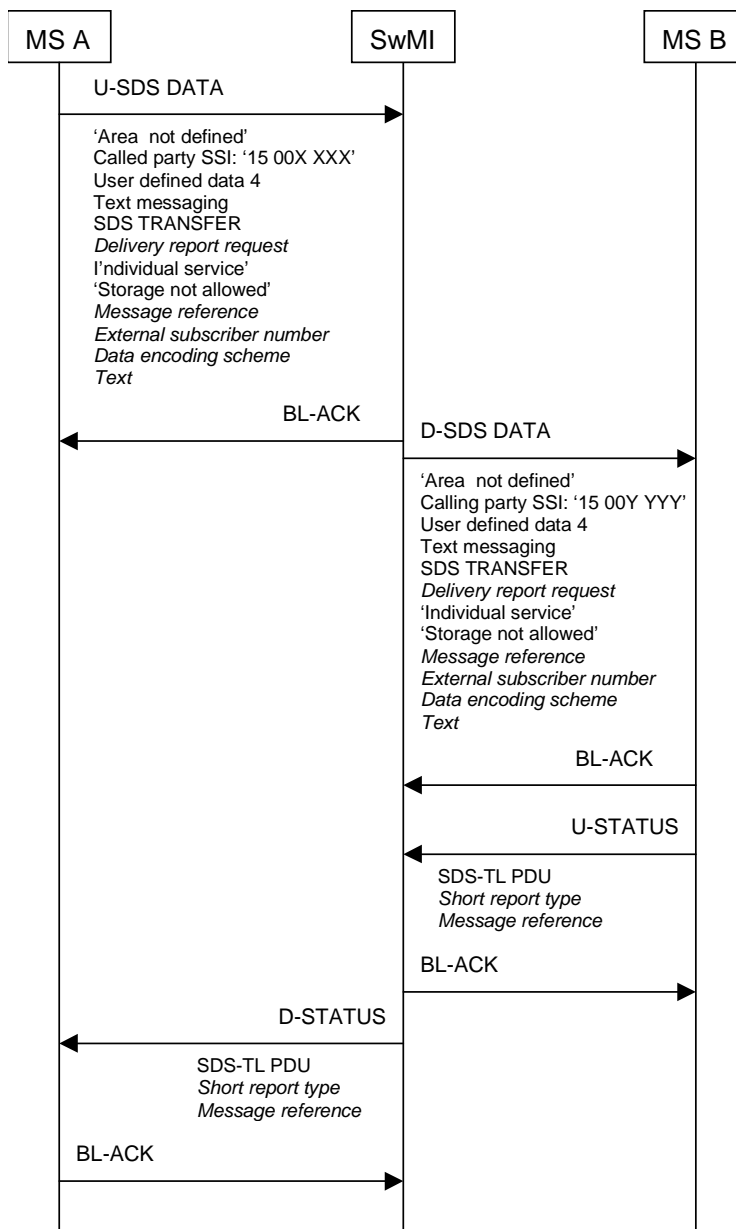

Figure C.5: Individually addressed SDS text message

NOTE: The FSSNs X XXX and Y YYY, serve only as an example, and could be anything from 1 to 6 digits in length.

Annex D: Pre defined gateway and server addresses

The block of 16 TETRA SSI identity values defined in table D.1 should be allocated in each TETRA network for access dedicated to the numbering implementations defined in annex A.

Table D.1: Predefined TETRA SSIs addresses

SSI		Function (note)	Usage
Decimal	Hexadecimal		
16 777 184	FFFFE0	PREDEF_E164	E.164 [i.4] gateway
16 777 185	FFFFE1	PREDEF_ISDN	ISDN gateway
16 777 186	FFFFE2	PREDEF_PABX	PABX gateway
16 777 187	FFFFE3	PREDEF_RUN	RUN gateway
16 777 188	FFFFE4	PREDEF_SDS_Service_Centre	Universal SDS Store and Forward Service Centre
16 777 189	FFFFE5	Reserved	Reserved
16 777 190	FFFFE6	Reserved	Reserved
16 777 191	FFFFE7	Reserved	Reserved
16 777 192	FFFFE8	Reserved	Reserved
16 777 193	FFFFE9	Reserved	Reserved
16 777 194	FFFFEA	Reserved	Reserved
16 777 195	FFFFEB	Reserved	Reserved
16 777 196	FFFFEC	Reserved	Reserved
16 777 197	FFFFED	Reserved	Reserved
16 777 198	FFFFEE	Reserved	Reserved
16 777 199	FFFFEF	Reserved	Reserved
NOTE: The functions are referenced in the Numbering Implementations, annex B, and mapping over the air interface, annex A.			

Annex E: Bibliography

ETSI EN 301 040: "Terrestrial Trunked Radio (TETRA); Security; Lawful Interception (LI) interface".

ETSI EG 202 118: "Services and Protocols for Advanced Networks (SPAN); The structure of the TETRA numbering resource, interworking and high level policy for administration".

Annex F: Change requests

The present document includes change requests as presented in table F.1.

Table F.1: Change requests

No	CR vers.	Document Version	Clauses affected	Title	CR Status
001	11	V1.2.1	Annex D	Address for service centre	WG3 approved 090226
002	11	V1.2.1	2, 3.1, 5.1.1, 5.1.2, 5.3.3, 8.1, 8.2, 8.2.1, 8.2.2, B.1	Modification of references	WG3 approved 090226

History

Document history		
Edition 1	July 1998	Publication as ETR 300-5
V1.2.1	January 2003	Publication
V1.3.1	March 2010	Publication